

Network Working Group
Request for Comments: 2408
Category: Standards Track

D. Maughan
National Security Agency
M. Schertler
Securify, Inc.
M. Schneider
National Security Agency
J. Turner
RABA Technologies, Inc.
November 1998

Internet Security Association and Key Management Protocol (ISAKMP)

Status of this Memo

This document specifies an Internet standards track protocol for the Internet community, and requests discussion and suggestions for improvements. Please refer to the current edition of the "Internet Official Protocol Standards" (STD 1) for the standardization state and status of this protocol. Distribution of this memo is unlimited.

Copyright Notice

Copyright (C) The Internet Society (1998). All Rights Reserved.

Abstract

This memo describes a protocol utilizing security concepts necessary for establishing Security Associations (SA) and cryptographic keys in an Internet environment. A Security Association protocol that negotiates, establishes, modifies and deletes Security Associations and their attributes is required for an evolving Internet, where there will be numerous security mechanisms and several options for each security mechanism. The key management protocol must be robust in order to handle public key generation for the Internet community at large and private key requirements for those private networks with that requirement. The Internet Security Association and Key Management Protocol (ISAKMP) defines the procedures for authenticating a communicating peer, creation and management of Security Associations, key generation techniques, and threat mitigation (e.g. denial of service and replay attacks). All of these are necessary to establish and maintain secure communications (via IP Security Service or any other security protocol) in an Internet environment.

Table of Contents

1	Introduction	4
1.1	Requirements Terminology	5
1.2	The Need for Negotiation	5
1.3	What can be Negotiated?	6
1.4	Security Associations and Management	7
1.4.1	Security Associations and Registration	7
1.4.2	ISAKMP Requirements	8
1.5	Authentication	8
1.5.1	Certificate Authorities	9
1.5.2	Entity Naming	9
1.5.3	ISAKMP Requirements	10
1.6	Public Key Cryptography	10
1.6.1	Key Exchange Properties	11
1.6.2	ISAKMP Requirements	12
1.7	ISAKMP Protection	12
1.7.1	Anti-Clogging (Denial of Service)	12
1.7.2	Connection Hijacking	13
1.7.3	Man-in-the-Middle Attacks	13
1.8	Multicast Communications	13
2	Terminology and Concepts	14
2.1	ISAKMP Terminology	14
2.2	ISAKMP Placement	16
2.3	Negotiation Phases	16
2.4	Identifying Security Associations	17
2.5	Miscellaneous	20
2.5.1	Transport Protocol	20
2.5.2	RESERVED Fields	20
2.5.3	Anti-Clogging Token ("Cookie") Creation	20
3	ISAKMP Payloads	21
3.1	ISAKMP Header Format	21
3.2	Generic Payload Header	25
3.3	Data Attributes	25
3.4	Security Association Payload	27
3.5	Proposal Payload	28
3.6	Transform Payload	29
3.7	Key Exchange Payload	31
3.8	Identification Payload	32
3.9	Certificate Payload	33
3.10	Certificate Request Payload	34
3.11	Hash Payload	36
3.12	Signature Payload	37
3.13	Nonce Payload	37
3.14	Notification Payload	38
3.14.1	Notify Message Types	40
3.15	Delete Payload	41
3.16	Vendor ID Payload	43

4	ISAKMP Exchanges	44
4.1	ISAKMP Exchange Types	45
4.1.1	Notation	46
4.2	Security Association Establishment	46
4.2.1	Security Association Establishment Examples	48
4.3	Security Association Modification	50
4.4	Base Exchange	51
4.5	Identity Protection Exchange	52
4.6	Authentication Only Exchange	54
4.7	Aggressive Exchange	55
4.8	Informational Exchange	57
5	ISAKMP Payload Processing	58
5.1	General Message Processing	58
5.2	ISAKMP Header Processing	59
5.3	Generic Payload Header Processing	61
5.4	Security Association Payload Processing	62
5.5	Proposal Payload Processing	63
5.6	Transform Payload Processing	64
5.7	Key Exchange Payload Processing	65
5.8	Identification Payload Processing	66
5.9	Certificate Payload Processing	66
5.10	Certificate Request Payload Processing	67
5.11	Hash Payload Processing	69
5.12	Signature Payload Processing	69
5.13	Nonce Payload Processing	70
5.14	Notification Payload Processing	71
5.15	Delete Payload Processing	73
6	Conclusions	75
A	ISAKMP Security Association Attributes	77
A.1	Background/Rationale	77
A.2	Internet IP Security DOI Assigned Value	77
A.3	Supported Security Protocols	77
A.4	ISAKMP Identification Type Values	78
A.4.1	ID_IPV4_ADDR	78
A.4.2	ID_IPV4_ADDR_SUBNET	78
A.4.3	ID_IPV6_ADDR	78
A.4.4	ID_IPV6_ADDR_SUBNET	78
B	Defining a new Domain of Interpretation	79
B.1	Situation	79
B.2	Security Policies	80
B.3	Naming Schemes	80
B.4	Syntax for Specifying Security Services	80
B.5	Payload Specification	80
B.6	Defining new Exchange Types	80
	Security Considerations	81
	IANA Considerations	81
	Domain of Interpretation	81
	Supported Security Protocols	82

Acknowledgements	82
References	82
Authors' Addresses	85
Full Copyright Statement	86

List of Figures

1	ISAKMP Relationships	16
2	ISAKMP Header Format	22
3	Generic Payload Header	25
4	Data Attributes	26
5	Security Association Payload	27
6	Proposal Payload Format	28
7	Transform Payload Format	30
8	Key Exchange Payload Format	31
9	Identification Payload Format	32
10	Certificate Payload Format	33
11	Certificate Request Payload Format	34
12	Hash Payload Format	36
13	Signature Payload Format	37
14	Nonce Payload Format	38
15	Notification Payload Format	39
16	Delete Payload Format	42
17	Vendor ID Payload Format	44

1 Introduction

This document describes an Internet Security Association and Key Management Protocol (ISAKMP). ISAKMP combines the security concepts of authentication, key management, and security associations to establish the required security for government, commercial, and private communications on the Internet.

The Internet Security Association and Key Management Protocol (ISAKMP) defines procedures and packet formats to establish, negotiate, modify and delete Security Associations (SA). SAs contain all the information required for execution of various network security services, such as the IP layer services (such as header authentication and payload encapsulation), transport or application layer services, or self-protection of negotiation traffic. ISAKMP defines payloads for exchanging key generation and authentication data. These formats provide a consistent framework for transferring key and authentication data which is independent of the key generation technique, encryption algorithm and authentication mechanism.

ISAKMP is distinct from key exchange protocols in order to cleanly separate the details of security association management (and key management) from the details of key exchange. There may be many different key exchange protocols, each with different security properties. However, a common framework is required for agreeing to the format of SA attributes, and for negotiating, modifying, and deleting SAs. ISAKMP serves as this common framework.

Separating the functionality into three parts adds complexity to the security analysis of a complete ISAKMP implementation. However, the separation is critical for interoperability between systems with differing security requirements, and should also simplify the analysis of further evolution of a ISAKMP server.

ISAKMP is intended to support the negotiation of SAs for security protocols at all layers of the network stack (e.g., IPSEC, TLS, TLSP, OSPF, etc.). By centralizing the management of the security associations, ISAKMP reduces the amount of duplicated functionality within each security protocol. ISAKMP can also reduce connection setup time, by negotiating a whole stack of services at once.

The remainder of section 1 establishes the motivation for security negotiation and outlines the major components of ISAKMP, i.e. Security Associations and Management, Authentication, Public Key Cryptography, and Miscellaneous items. Section 2 presents the terminology and concepts associated with ISAKMP. Section 3 describes the different ISAKMP payload formats. Section 4 describes how the payloads of ISAKMP are composed together as exchange types to establish security associations and perform key exchanges in an authenticated manner. Additionally, security association modification, deletion, and error notification are discussed. Section 5 describes the processing of each payload within the context of ISAKMP exchanges, including error handling and associated actions. The appendices provide the attribute values necessary for ISAKMP and requirement for defining a new Domain of Interpretation (DOI) within ISAKMP.

1.1 Requirements Terminology

The keywords MUST, MUST NOT, REQUIRED, SHALL, SHALL NOT, SHOULD, SHOULD NOT, RECOMMENDED, MAY, and OPTIONAL, when they appear in this document, are to be interpreted as described in [RFC-2119].

1.2 The Need for Negotiation

ISAKMP extends the assertion in [DOW92] that authentication and key exchanges must be combined for better security to include security association exchanges. The security services required for

communications depends on the individual network configurations and environments. Organizations are setting up Virtual Private Networks (VPN), also known as Intranets, that will require one set of security functions for communications within the VPN and possibly many different security functions for communications outside the VPN to support geographically separate organizational components, customers, suppliers, sub-contractors (with their own VPNs), government, and others. Departments within large organizations may require a number of security associations to separate and protect data (e.g. personnel data, company proprietary data, medical) on internal networks and other security associations to communicate within the same department. Nomadic users wanting to "phone home" represent another set of security requirements. These requirements must be tempered with bandwidth challenges. Smaller groups of people may meet their security requirements by setting up "Webs of Trust". ISAKMP exchanges provide these assorted networking communities the ability to present peers with the security functionality that the user supports in an authenticated and protected manner for agreement upon a common set of security attributes, i.e. an interoperable security association.

1.3 What can be Negotiated?

Security associations must support different encryption algorithms, authentication mechanisms, and key establishment algorithms for other security protocols, as well as IP Security. Security associations must also support host-oriented certificates for lower layer protocols and user-oriented certificates for higher level protocols. Algorithm and mechanism independence is required in applications such as e-mail, remote login, and file transfer, as well as in session oriented protocols, routing protocols, and link layer protocols. ISAKMP provides a common security association and key establishment protocol for this wide range of security protocols, applications, security requirements, and network environments.

ISAKMP is not bound to any specific cryptographic algorithm, key generation technique, or security mechanism. This flexibility is beneficial for a number of reasons. First, it supports the dynamic communications environment described above. Second, the independence from specific security mechanisms and algorithms provides a forward migration path to better mechanisms and algorithms. When improved security mechanisms are developed or new attacks against current encryption algorithms, authentication mechanisms and key exchanges are discovered, ISAKMP will allow the updating of the algorithms and mechanisms without having to develop a completely new KMP or patch the current one.

ISAKMP has basic requirements for its authentication and key exchange components. These requirements guard against denial of service, replay / reflection, man-in-the-middle, and connection hijacking attacks. This is important because these are the types of attacks that are targeted against protocols. Complete Security Association (SA) support, which provides mechanism and algorithm independence, and protection from protocol threats are the strengths of ISAKMP.

1.4 Security Associations and Management

A Security Association (SA) is a relationship between two or more entities that describes how the entities will utilize security services to communicate securely. This relationship is represented by a set of information that can be considered a contract between the entities. The information must be agreed upon and shared between all the entities. Sometimes the information alone is referred to as an SA, but this is just a physical instantiation of the existing relationship. The existence of this relationship, represented by the information, is what provides the agreed upon security information needed by entities to securely interoperate. All entities must adhere to the SA for secure communications to be possible. When accessing SA attributes, entities use a pointer or identifier referred to as the Security Parameter Index (SPI). [SEC-ARCH] provides details on IP Security Associations (SA) and Security Parameter Index (SPI) definitions.

1.4.1 Security Associations and Registration

The SA attributes required and recommended for the IP Security (AH, ESP) are defined in [SEC-ARCH]. The attributes specified for an IP Security SA include, but are not limited to, authentication mechanism, cryptographic algorithm, algorithm mode, key length, and Initialization Vector (IV). Other protocols that provide algorithm and mechanism independent security MUST define their requirements for SA attributes. The separation of ISAKMP from a specific SA definition is important to ensure ISAKMP can establish SAs for all possible security protocols and applications.

NOTE: See [IPDOI] for a discussion of SA attributes that should be considered when defining a security protocol or application.

In order to facilitate easy identification of specific attributes (e.g. a specific encryption algorithm) among different network entities the attributes must be assigned identifiers and these identifiers must be registered by a central authority. The Internet Assigned Numbers Authority (IANA) provides this function for the Internet.

1.4.2 ISAKMP Requirements

Security Association (SA) establishment MUST be part of the key management protocol defined for IP based networks. The SA concept is required to support security protocols in a diverse and dynamic networking environment. Just as authentication and key exchange must be linked to provide assurance that the key is established with the authenticated party [DOW92], SA establishment must be linked with the authentication and the key exchange protocol.

ISAKMP provides the protocol exchanges to establish a security association between negotiating entities followed by the establishment of a security association by these negotiating entities in behalf of some protocol (e.g. ESP/AH). First, an initial protocol exchange allows a basic set of security attributes to be agreed upon. This basic set provides protection for subsequent ISAKMP exchanges. It also indicates the authentication method and key exchange that will be performed as part of the ISAKMP protocol. If a basic set of security attributes is already in place between the negotiating server entities, the initial ISAKMP exchange may be skipped and the establishment of a security association can be done directly. After the basic set of security attributes has been agreed upon, initial identity authenticated, and required keys generated, the established SA can be used for subsequent communications by the entity that invoked ISAKMP. The basic set of SA attributes that MUST be implemented to provide ISAKMP interoperability are defined in Appendix A.

1.5 Authentication

A very important step in establishing secure network communications is authentication of the entity at the other end of the communication. Many authentication mechanisms are available. Authentication mechanisms fall into two categories of strength - weak and strong. Sending cleartext keys or other unprotected authenticating information over a network is weak, due to the threat of reading them with a network sniffer. Additionally, sending one-way hashed poorly-chosen keys with low entropy is also weak, due to the threat of brute-force guessing attacks on the sniffed messages. While passwords can be used for establishing identity, they are not considered in this context because of recent statements from the Internet Architecture Board [IAB]. Digital signatures, such as the Digital Signature Standard (DSS) and the Rivest-Shamir-Adleman (RSA) signature, are public key based strong authentication mechanisms. When using public key digital signatures each entity requires a public key and a private key. Certificates are an essential part of a digital signature authentication mechanism. Certificates bind a specific entity's identity (be it host, network, user, or

application) to its public keys and possibly other security-related information such as privileges, clearances, and compartments. Authentication based on digital signatures requires a trusted third party or certificate authority to create, sign and properly distribute certificates. For more detailed information on digital signatures, such as DSS and RSA, and certificates see [Schneier].

1.5.1 Certificate Authorities

Certificates require an infrastructure for generation, verification, revocation, management and distribution. The Internet Policy Registration Authority (IPRA) [RFC-1422] has been established to direct this infrastructure for the IETF. The IPRA certifies Policy Certification Authorities (PCA). PCAs control Certificate Authorities (CA) which certify users and subordinate entities. Current certificate related work includes the Domain Name System (DNS) Security Extensions [DNSSEC] which will provide signed entity keys in the DNS. The Public Key Infrastructure (PKIX) working group is specifying an Internet profile for X.509 certificates. There is also work going on in industry to develop X.500 Directory Services which would provide X.509 certificates to users. The U.S. Post Office is developing a (CA) hierarchy. The NIST Public Key Infrastructure Working Group has also been doing work in this area. The DOD Multi Level Information System Security Initiative (MISSI) program has begun deploying a certificate infrastructure for the U.S. Government. Alternatively, if no infrastructure exists, the PGP Web of Trust certificates can be used to provide user authentication and privacy in a community of users who know and trust each other.

1.5.2 Entity Naming

An entity's name is its identity and is bound to its public keys in certificates. The CA MUST define the naming semantics for the certificates it issues. See the UNINETT PCA Policy Statements [Berge] for an example of how a CA defines its naming policy. When the certificate is verified, the name is verified and that name will have meaning within the realm of that CA. An example is the DNS security extensions which make DNS servers CAs for the zones and nodes they serve. Resource records are provided for public keys and signatures on those keys. The names associated with the keys are IP addresses and domain names which have meaning to entities accessing the DNS for this information. A Web of Trust is another example. When webs of trust are set up, names are bound with the public keys. In PGP the name is usually the entity's e-mail address which has meaning to those, and only those, who understand e-mail. Another web of trust could use an entirely different naming scheme.

1.5.3 ISAKMP Requirements

Strong authentication **MUST** be provided on ISAKMP exchanges. Without being able to authenticate the entity at the other end, the Security Association (SA) and session key established are suspect. Without authentication you are unable to trust an entity's identification, which makes access control questionable. While encryption (e.g. ESP) and integrity (e.g. AH) will protect subsequent communications from passive eavesdroppers, without authentication it is possible that the SA and key may have been established with an adversary who performed an active man-in-the-middle attack and is now stealing all your personal data.

A digital signature algorithm **MUST** be used within ISAKMP's authentication component. However, ISAKMP does not mandate a specific signature algorithm or certificate authority (CA). ISAKMP allows an entity initiating communications to indicate which CAs it supports. After selection of a CA, the protocol provides the messages required to support the actual authentication exchange. The protocol provides a facility for identification of different certificate authorities, certificate types (e.g. X.509, PKCS #7, PGP, DNS SIG and KEY records), and the exchange of the certificates identified.

ISAKMP utilizes digital signatures, based on public key cryptography, for authentication. There are other strong authentication systems available, which could be specified as additional optional authentication mechanisms for ISAKMP. Some of these authentication systems rely on a trusted third party called a key distribution center (KDC) to distribute secret session keys. An example is Kerberos, where the trusted third party is the Kerberos server, which holds secret keys for all clients and servers within its network domain. A client's proof that it holds its secret key provides authentication to a server.

The ISAKMP specification does not specify the protocol for communicating with the trusted third parties (TTP) or certificate directory services. These protocols are defined by the TTP and directory service themselves and are outside the scope of this specification. The use of these additional services and protocols will be described in a Key Exchange specific document.

1.6 Public Key Cryptography

Public key cryptography is the most flexible, scalable, and efficient way for users to obtain the shared secrets and session keys needed to support the large number of ways Internet users will interoperate. Many key generation algorithms, that have different properties, are

available to users (see [DOW92], [ANSI], and [Oakley]). Properties of key exchange protocols include the key establishment method, authentication, symmetry, perfect forward secrecy, and back traffic protection.

NOTE: Cryptographic keys can protect information for a considerable length of time. However, this is based on the assumption that keys used for protection of communications are destroyed after use and not kept for any reason.

1.6.1 Key Exchange Properties

Key Establishment (Key Generation / Key Transport): The two common methods of using public key cryptography for key establishment are key transport and key generation. An example of key transport is the use of the RSA algorithm to encrypt a randomly generated session key (for encrypting subsequent communications) with the recipient's public key. The encrypted random key is then sent to the recipient, who decrypts it using his private key. At this point both sides have the same session key, however it was created based on input from only one side of the communications. The benefit of the key transport method is that it has less computational overhead than the following method. The Diffie-Hellman (D-H) algorithm illustrates key generation using public key cryptography. The D-H algorithm is begun by two users exchanging public information. Each user then mathematically combines the other's public information along with their own secret information to compute a shared secret value. This secret value can be used as a session key or as a key encryption key for encrypting a randomly generated session key. This method generates a session key based on public and secret information held by both users. The benefit of the D-H algorithm is that the key used for encrypting messages is based on information held by both users and the independence of keys from one key exchange to another provides perfect forward secrecy. Detailed descriptions of these algorithms can be found in [Schneier]. There are a number of variations on these two key generation schemes and these variations do not necessarily interoperate.

Key Exchange Authentication: Key exchanges may be authenticated during the protocol or after protocol completion. Authentication of the key exchange during the protocol is provided when each party provides proof it has the secret session key before the end of the protocol. Proof can be provided by encrypting known data in the secret session key during the protocol exchange. Authentication after the protocol must occur in subsequent communications. Authentication during the protocol is preferred so subsequent communications are not initiated if the secret session key is not established with the desired party.

Key Exchange Symmetry: A key exchange provides symmetry if either party can initiate the exchange and exchanged messages can cross in transit without affecting the key that is generated. This is desirable so that computation of the keys does not require either party to know who initiated the exchange. While key exchange symmetry is desirable, symmetry in the entire key management protocol may provide a vulnerability to reflection attacks.

Perfect Forward Secrecy: As described in [DOW92], an authenticated key exchange protocol provides perfect forward secrecy if disclosure of longterm secret keying material does not compromise the secrecy of the exchanged keys from previous communications. The property of perfect forward secrecy does not apply to key exchange without authentication.

1.6.2 ISAKMP Requirements

An authenticated key exchange MUST be supported by ISAKMP. Users SHOULD choose additional key establishment algorithms based on their requirements. ISAKMP does not specify a specific key exchange. However, [IKE] describes a proposal for using the Oakley key exchange [Oakley] in conjunction with ISAKMP. Requirements that should be evaluated when choosing a key establishment algorithm include establishment method (generation vs. transport), perfect forward secrecy, computational overhead, key escrow, and key strength. Based on user requirements, ISAKMP allows an entity initiating communications to indicate which key exchanges it supports. After selection of a key exchange, the protocol provides the messages required to support the actual key establishment.

1.7 ISAKMP Protection

1.7.1 Anti-Clogging (Denial of Service)

Of the numerous security services available, protection against denial of service always seems to be one of the most difficult to address. A "cookie" or anti-clogging token (ACT) is aimed at protecting the computing resources from attack without spending excessive CPU resources to determine its authenticity. An exchange prior to CPU-intensive public key operations can thwart some denial of service attempts (e.g. simple flooding with bogus IP source addresses). Absolute protection against denial of service is impossible, but this anti-clogging token provides a technique for making it easier to handle. The use of an anti-clogging token was introduced by Karn and Simpson in [Karn].

It should be noted that in the exchanges shown in section 4, the anticlogging mechanism should be used in conjunction with a garbage-state collection mechanism; an attacker can still flood a server using packets with bogus IP addresses and cause state to be created. Such aggressive memory management techniques SHOULD be employed by protocols using ISAKMP that do not go through an initial, anti-clogging only phase, as was done in [Karn].

1.7.2 Connection Hijacking

ISAKMP prevents connection hijacking by linking the authentication, key exchange and security association exchanges. This linking prevents an attacker from allowing the authentication to complete and then jumping in and impersonating one entity to the other during the key and security association exchanges.

1.7.3 Man-in-the-Middle Attacks

Man-in-the-Middle attacks include interception, insertion, deletion, and modification of messages, reflecting messages back at the sender, replaying old messages and redirecting messages. ISAKMP features prevent these types of attacks from being successful. The linking of the ISAKMP exchanges prevents the insertion of messages in the protocol exchange. The ISAKMP protocol state machine is defined so deleted messages will not cause a partial SA to be created, the state machine will clear all state and return to idle. The state machine also prevents reflection of a message from causing harm. The requirement for a new cookie with time variant material for each new SA establishment prevents attacks that involve replaying old messages. The ISAKMP strong authentication requirement prevents an SA from being established with anyone other than the intended party. Messages may be redirected to a different destination or modified but this will be detected and an SA will not be established. The ISAKMP specification defines where abnormal processing has occurred and recommends notifying the appropriate party of this abnormality.

1.8 Multicast Communications

It is expected that multicast communications will require the same security services as unicast communications and may introduce the need for additional security services. The issues of distributing SPIs for multicast traffic are presented in [SEC-ARCH]. Multicast security issues are also discussed in [RFC-1949] and [BC]. A future extension to ISAKMP will support multicast key distribution. For an introduction to the issues related to multicast security, consult the Internet Drafts, [RFC-2094] and [RFC-2093], describing Sparta's research in this area.

2 Terminology and Concepts

2.1 ISAKMP Terminology

Security Protocol: A Security Protocol consists of an entity at a single point in the network stack, performing a security service for network communication. For example, IPSEC ESP and IPSEC AH are two different security protocols. TLS is another example. Security Protocols may perform more than one service, for example providing integrity and confidentiality in one module.

Protection Suite: A protection suite is a list of the security services that must be applied by various security protocols. For example, a protection suite may consist of DES encryption in IP ESP, and keyed MD5 in IP AH. All of the protections in a suite must be treated as a single unit. This is necessary because security services in different security protocols can have subtle interactions, and the effects of a suite must be analyzed and verified as a whole.

Security Association (SA): A Security Association is a security-protocol- specific set of parameters that completely defines the services and mechanisms necessary to protect traffic at that security protocol location. These parameters can include algorithm identifiers, modes, cryptographic keys, etc. The SA is referred to by its associated security protocol (for example, "ISAKMP SA", "ESP SA", "TLS SA").

ISAKMP SA: An SA used by the ISAKMP servers to protect their own traffic. Sections 2.3 and 2.4 provide more details about ISAKMP SAs.

Security Parameter Index (SPI): An identifier for a Security Association, relative to some security protocol. Each security protocol has its own "SPI-space". A (security protocol, SPI) pair may uniquely identify an SA. The uniqueness of the SPI is implementation dependent, but could be based per system, per protocol, or other options. Depending on the DOI, additional information (e.g. host address) may be necessary to identify an SA. The DOI will also determine which SPIs (i.e. initiator's or responder's) are sent during communication.

Domain of Interpretation: A Domain of Interpretation (DOI) defines payload formats, exchange types, and conventions for naming security-relevant information such as security policies or cryptographic algorithms and modes. A Domain of Interpretation (DOI) identifier is used to interpret the payloads of ISAKMP payloads. A system SHOULD support multiple Domains of Interpretation simultaneously. The concept of a DOI is based on previous work by

the TSIG CIPSO Working Group, but extends beyond security label interpretation to include naming and interpretation of security services. A DOI defines:

- o A "situation": the set of information that will be used to determine the required security services.
- o The set of security policies that must, and may, be supported.
- o A syntax for the specification of proposed security services.
- o A scheme for naming security-relevant information, including encryption algorithms, key exchange algorithms, security policy attributes, and certificate authorities.
- o The specific formats of the various payload contents.
- o Additional exchange types, if required.

The rules for the IETF IP Security DOI are presented in [IPDOI]. Specifications of the rules for customized DOIs will be presented in separate documents.

Situation: A situation contains all of the security-relevant information that a system considers necessary to decide the security services required to protect the session being negotiated. The situation may include addresses, security classifications, modes of operation (normal vs. emergency), etc.

Proposal: A proposal is a list, in decreasing order of preference, of the protection suites that a system considers acceptable to protect traffic under a given situation.

Payload: ISAKMP defines several types of payloads, which are used to transfer information such as security association data, or key exchange data, in DOI-defined formats. A payload consists of a generic payload header and a string of octets that is opaque to ISAKMP. ISAKMP uses DOI-specific functionality to synthesize and interpret these payloads. Multiple payloads can be sent in a single ISAKMP message. See section 3 for more details on the payload types, and [IPDOI] for the formats of the IETF IP Security DOI payloads.

Exchange Type: An exchange type is a specification of the number of messages in an ISAKMP exchange, and the payload types that are contained in each of those messages. Each exchange type is designed to provide a particular set of security services, such as anonymity of the participants, perfect forward secrecy of the keying material, authentication of the participants, etc. Section 4.1 defines the

default set of ISAKMP exchange types. Other exchange types can be added to support additional key exchanges, if required.

2.2 ISAKMP Placement

Figure 1 is a high level view of the placement of ISAKMP within a system context in a network architecture. An important part of negotiating security services is to consider the entire "stack" of individual SAs as a unit. This is referred to as a "protection suite".

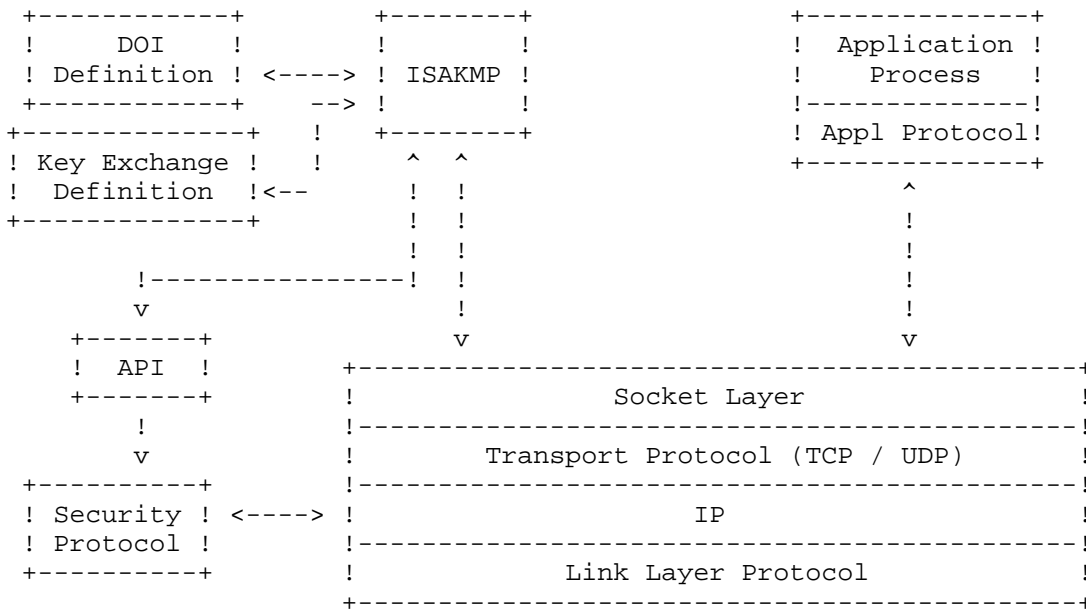

Figure 1: ISAKMP Relationships

2.3 Negotiation Phases

ISAKMP offers two "phases" of negotiation. In the first phase, two entities (e.g. ISAKMP servers) agree on how to protect further negotiation traffic between themselves, establishing an ISAKMP SA. This ISAKMP SA is then used to protect the negotiations for the Protocol SA being requested. Two entities (e.g. ISAKMP servers) can negotiate (and have active) multiple ISAKMP SAs.

The second phase of negotiation is used to establish security associations for other security protocols. This second phase can be used to establish many security associations. The security associations established by ISAKMP during this phase can be used by a security protocol to protect many message/data exchanges.

While the two-phased approach has a higher start-up cost for most simple scenarios, there are several reasons that it is beneficial for most cases.

First, entities (e.g. ISAKMP servers) can amortize the cost of the first phase across several second phase negotiations. This allows multiple SAs to be established between peers over time without having to start over for each communication.

Second, security services negotiated during the first phase provide security properties for the second phase. For example, after the first phase of negotiation, the encryption provided by the ISAKMP SA can provide identity protection, potentially allowing the use of simpler second-phase exchanges. On the other hand, if the channel established during the first phase is not adequate to protect identities, then the second phase must negotiate adequate security mechanisms.

Third, having an ISAKMP SA in place considerably reduces the cost of ISAKMP management activity - without the "trusted path" that an ISAKMP SA gives you, the entities (e.g. ISAKMP servers) would have to go through a complete re-authentication for each error notification or deletion of an SA.

Negotiation during each phase is accomplished using ISAKMP-defined exchanges (see section 4) or exchanges defined for a key exchange within a DOI.

Note that security services may be applied differently in each negotiation phase. For example, different parties are being authenticated during each of the phases of negotiation. During the first phase, the parties being authenticated may be the ISAKMP servers/hosts, while during the second phase, users or application level programs are being authenticated.

2.4 Identifying Security Associations

While bootstrapping secure channels between systems, ISAKMP cannot assume the existence of security services, and must provide some protections for itself. Therefore, ISAKMP considers an ISAKMP Security Association to be different than other types, and manages ISAKMP SAs itself, in their own name space. ISAKMP uses the two

cookie fields in the ISAKMP header to identify ISAKMP SAs. The Message ID in the ISAKMP Header and the SPI field in the Proposal payload are used during SA establishment to identify the SA for other security protocols. The interpretation of these four fields is dependent on the operation taking place.

The following table shows the presence or absence of several fields during SA establishment. The following fields are necessary for various operations associated with SA establishment: cookies in the ISAKMP header, the ISAKMP Header Message ID field, and the SPI field in the Proposal payload. An 'X' in the column means the value MUST be present. An 'NA' in the column means a value in the column is Not Applicable to the operation.

#	Operation	I-Cookie	R-Cookie	Message ID	SPI
(1)	Start ISAKMP SA negotiation	X	0	0	0
(2)	Respond ISAKMP SA negotiation	X	X	0	0
(3)	Init other SA negotiation	X	X	X	X
(4)	Respond other SA negotiation	X	X	X	X
(5)	Other (KE, ID, etc.)	X	X	X/0	NA
(6)	Security Protocol (ESP, AH)	NA	NA	NA	X

In the first line (1) of the table, the initiator includes the Initiator Cookie field in the ISAKMP Header, using the procedures outlined in sections 2.5.3 and 3.1.

In the second line (2) of the table, the responder includes the Initiator and Responder Cookie fields in the ISAKMP Header, using the procedures outlined in sections 2.5.3 and 3.1. Additional messages may be exchanged between ISAKMP peers, depending on the ISAKMP exchange type used during the phase 1 negotiation. Once the phase 1 exchange is completed, the Initiator and Responder cookies are included in the ISAKMP Header of all subsequent communications between the ISAKMP peers.

During phase 1 negotiations, the initiator and responder cookies determine the ISAKMP SA. Therefore, the SPI field in the Proposal payload is redundant and MAY be set to 0 or it MAY contain the transmitting entity's cookie.

In the third line (3) of the table, the initiator associates a Message ID with the Protocols contained in the SA Proposal. This Message ID and the initiator's SPI(s) to be associated with each protocol in the Proposal are sent to the responder. The SPI(s) will be used by the security protocols once the phase 2 negotiation is completed.

In the fourth line (4) of the table, the responder includes the same Message ID and the responder's SPI(s) to be associated with each protocol in the accepted Proposal. This information is returned to the initiator.

In the fifth line (5) of the table, the initiator and responder use the Message ID field in the ISAKMP Header to keep track of the in-progress protocol negotiation. This is only applicable for a phase 2 exchange and the value MUST be 0 for a phase 1 exchange because the combined cookies identify the ISAKMP SA. The SPI field in the Proposal payload is not applicable because the Proposal payload is only used during the SA negotiation message exchange (steps 3 and 4).

In the sixth line (6) of the table, the phase 2 negotiation is complete. The security protocols use the SPI(s) to determine which security services and mechanisms to apply to the communication between them. The SPI value shown in the sixth line (6) is not the SPI field in the Proposal payload, but the SPI field contained within the security protocol header.

During the SA establishment, a SPI MUST be generated. ISAKMP is designed to handle variable sized SPIs. This is accomplished by using the SPI Size field within the Proposal payload during SA establishment. Handling of SPIs will be outlined by the DOI specification (e.g. [IPDOI]).

When a security association (SA) is initially established, one side assumes the role of initiator and the other the role of responder. Once the SA is established, both the original initiator and responder can initiate a phase 2 negotiation with the peer entity. Thus, ISAKMP SAs are bidirectional in nature.

Additionally, ISAKMP allows both initiator and responder to have some control during the negotiation process. While ISAKMP is designed to allow an SA negotiation that includes multiple proposals, the initiator can maintain some control by only making one proposal in accordance with the initiator's local security policy. Once the initiator sends a proposal containing more than one proposal (which are sent in decreasing preference order), the initiator relinquishes control to the responder. Once the responder is controlling the SA establishment, the responder can make its policy take precedence over the initiator within the context of the multiple options offered by the initiator. This is accomplished by selecting the proposal best suited for the responder's local security policy and returning this selection to the initiator.

2.5 Miscellaneous

2.5.1 Transport Protocol

ISAKMP can be implemented over any transport protocol or over IP itself. Implementations MUST include send and receive capability for ISAKMP using the User Datagram Protocol (UDP) on port 500. UDP Port 500 has been assigned to ISAKMP by the Internet Assigned Numbers Authority (IANA). Implementations MAY additionally support ISAKMP over other transport protocols or over IP itself.

2.5.2 RESERVED Fields

The existence of RESERVED fields within ISAKMP payloads are used strictly to preserve byte alignment. All RESERVED fields in the ISAKMP protocol MUST be set to zero (0) when a packet is issued. The receiver SHOULD check the RESERVED fields for a zero (0) value and discard the packet if other values are found.

2.5.3 Anti-Clogging Token ("Cookie") Creation

The details of cookie generation are implementation dependent, but MUST satisfy these basic requirements (originally stated by Phil Karn in [Karn]):

1. The cookie must depend on the specific parties. This prevents an attacker from obtaining a cookie using a real IP address and UDP port, and then using it to swamp the victim with Diffie-Hellman requests from randomly chosen IP addresses or ports.
2. It must not be possible for anyone other than the issuing entity to generate cookies that will be accepted by that entity. This implies that the issuing entity must use local secret information in the generation and subsequent verification of a cookie. It must not be possible to deduce this secret information from any particular cookie.
3. The cookie generation function must be fast to thwart attacks intended to sabotage CPU resources.

Karn's suggested method for creating the cookie is to perform a fast hash (e.g. MD5) over the IP Source and Destination Address, the UDP Source and Destination Ports and a locally generated secret random value. ISAKMP requires that the cookie be unique for each SA establishment to help prevent replay attacks, therefore, the date and time MUST be added to the information hashed. The generated cookies are placed in the ISAKMP Header (described in section 3.1) Initiator

and Responder cookie fields. These fields are 8 octets in length, thus, requiring a generated cookie to be 8 octets. Notify and Delete messages (see sections 3.14, 3.15, and 4.8) are uni-directional transmissions and are done under the protection of an existing ISAKMP SA, thus, not requiring the generation of a new cookie. One exception to this is the transmission of a Notify message during a Phase 1 exchange, prior to completing the establishment of an SA. Sections 3.14 and 4.8 provide additional details.

3 ISAKMP Payloads

ISAKMP payloads provide modular building blocks for constructing ISAKMP messages. The presence and ordering of payloads in ISAKMP is defined by and dependent upon the Exchange Type Field located in the ISAKMP Header (see Figure 2). The ISAKMP payload types are discussed in sections 3.4 through 3.15. The descriptions of the ISAKMP payloads, messages, and exchanges (see Section 4) are shown using network octet ordering.

3.1 ISAKMP Header Format

An ISAKMP message has a fixed header format, shown in Figure 2, followed by a variable number of payloads. A fixed header simplifies parsing, providing the benefit of protocol parsing software that is less complex and easier to implement. The fixed header contains the information required by the protocol to maintain state, process payloads and possibly prevent denial of service or replay attacks.

The ISAKMP Header fields are defined as follows:

- o Initiator Cookie (8 octets) - Cookie of entity that initiated SA establishment, SA notification, or SA deletion.
- o Responder Cookie (8 octets) - Cookie of entity that is responding to an SA establishment request, SA notification, or SA deletion.

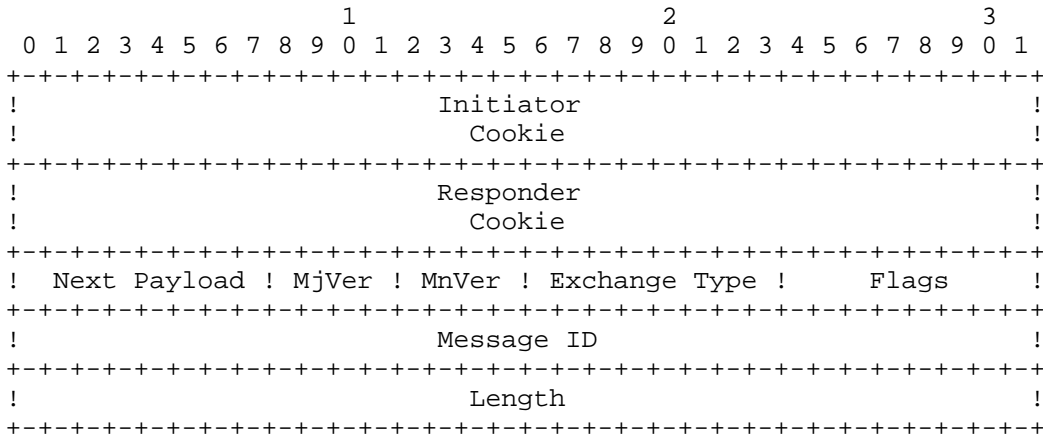

Figure 2: ISAKMP Header Format

- o Next Payload (1 octet) - Indicates the type of the first payload in the message. The format for each payload is defined in sections 3.4 through 3.16. The processing for the payloads is defined in section 5.

Next Payload Type	Value
NONE	0
Security Association (SA)	1
Proposal (P)	2
Transform (T)	3
Key Exchange (KE)	4
Identification (ID)	5
Certificate (CERT)	6
Certificate Request (CR)	7
Hash (HASH)	8
Signature (SIG)	9
Nonce (NONCE)	10
Notification (N)	11
Delete (D)	12
Vendor ID (VID)	13
RESERVED	14 - 127
Private USE	128 - 255

- o Major Version (4 bits) - indicates the major version of the ISAKMP protocol in use. Implementations based on this version of the ISAKMP Internet-Draft MUST set the Major Version to 1. Implementations based on previous versions of ISAKMP Internet-Drafts MUST set the Major Version to 0. Implementations SHOULD

never accept packets with a major version number larger than its own.

- o Minor Version (4 bits) - indicates the minor version of the ISAKMP protocol in use. Implementations based on this version of the ISAKMP Internet-Draft MUST set the Minor Version to 0. Implementations based on previous versions of ISAKMP Internet-Drafts MUST set the Minor Version to 1. Implementations SHOULD never accept packets with a minor version number larger than its own, given the major version numbers are identical.
- o Exchange Type (1 octet) - indicates the type of exchange being used. This dictates the message and payload orderings in the ISAKMP exchanges.

Exchange Type	Value
NONE	0
Base	1
Identity Protection	2
Authentication Only	3
Aggressive	4
Informational	5
ISAKMP Future Use	6 - 31
DOI Specific Use	32 - 239
Private Use	240 - 255

- o Flags (1 octet) - indicates specific options that are set for the ISAKMP exchange. The flags listed below are specified in the Flags field beginning with the least significant bit, i.e the Encryption bit is bit 0 of the Flags field, the Commit bit is bit 1 of the Flags field, and the Authentication Only bit is bit 2 of the Flags field. The remaining bits of the Flags field MUST be set to 0 prior to transmission.

-- E(ncryption Bit) (1 bit) - If set (1), all payloads following the header are encrypted using the encryption algorithm identified in the ISAKMP SA. The ISAKMP SA Identifier is the combination of the initiator and responder cookie. It is RECOMMENDED that encryption of communications be done as soon as possible between the peers. For all ISAKMP exchanges described in section 4.1, the encryption SHOULD begin after both parties have exchanged Key Exchange payloads. If the E(ncryption Bit) is not set (0), the payloads are not encrypted.

-- C(ommit Bit) (1 bit) - This bit is used to signal key exchange synchronization. It is used to ensure that encrypted material is not received prior to completion of the SA establishment. The Commit Bit can be set (at anytime) by either party participating in the SA establishment, and can be used during both phases of an ISAKMP SA establishment. However, the value MUST be reset after the Phase 1 negotiation. If set(1), the entity which did not set the Commit Bit MUST wait for an Informational Exchange containing a Notify payload (with the CONNECTED Notify Message) from the entity which set the Commit Bit. In this instance, the Message ID field of the Informational Exchange MUST contain the Message ID of the original ISAKMP Phase 2 SA negotiation. This is done to ensure that the Informational Exchange with the CONNECTED Notify Message can be associated with the correct Phase 2 SA. The receipt and processing of the Informational Exchange indicates that the SA establishment was successful and either entity can now proceed with encrypted traffic communication. In addition to synchronizing key exchange, the Commit Bit can be used to protect against loss of transmissions over unreliable networks and guard against the need for multiple re-transmissions.

NOTE: It is always possible that the final message of an exchange can be lost. In this case, the entity expecting to receive the final message of an exchange would receive the Phase 2 SA negotiation message following a Phase 1 exchange or encrypted traffic following a Phase 2 exchange. Handling of this situation is not standardized, but we propose the following possibilities. If the entity awaiting the Informational Exchange can verify the received message (i.e. Phase 2 SA negotiation message or encrypted traffic), then they MAY consider the SA was established and continue processing. The other option is to retransmit the last ISAKMP message to force the other entity to retransmit the final message. This suggests that implementations may consider retaining the last message (locally) until they are sure the SA is established.

-- A(uthentication Only Bit) (1 bit) - This bit is intended for use with the Informational Exchange with a Notify payload and will allow the transmission of information with integrity checking, but no encryption (e.g. "emergency mode"). Section 4.8 states that a Phase 2 Informational Exchange MUST be sent under the protection of an ISAKMP SA. This is the only exception to that policy. If the Authentication Only bit is set (1), only authentication security services will be applied to the entire Notify payload of the Informational Exchange and

the payload will not be encrypted.

- o Message ID (4 octets) - Unique Message Identifier used to identify protocol state during Phase 2 negotiations. This value is randomly generated by the initiator of the Phase 2 negotiation. In the event of simultaneous SA establishments (i.e. collisions), the value of this field will likely be different because they are independently generated and, thus, two security associations will progress toward establishment. However, it is unlikely there will be absolute simultaneous establishments. During Phase 1 negotiations, the value MUST be set to 0.
- o Length (4 octets) - Length of total message (header + payloads) in octets. Encryption can expand the size of an ISAKMP message.

3.2 Generic Payload Header

Each ISAKMP payload defined in sections 3.4 through 3.16 begins with a generic header, shown in Figure 3, which provides a payload "chaining" capability and clearly defines the boundaries of a payload.

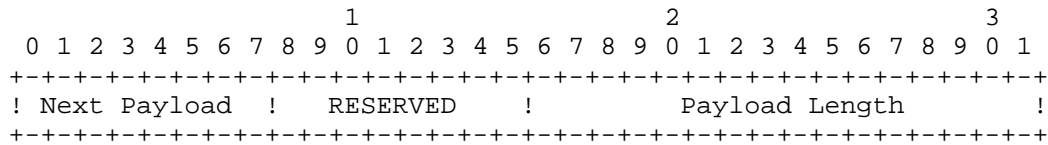

Figure 3: Generic Payload Header

The Generic Payload Header fields are defined as follows:

- o Next Payload (1 octet) - Identifier for the payload type of the next payload in the message. If the current payload is the last in the message, then this field will be 0. This field provides the "chaining" capability.
- o RESERVED (1 octet) - Unused, set to 0.
- o Payload Length (2 octets) - Length in octets of the current payload, including the generic payload header.

3.3 Data Attributes

There are several instances within ISAKMP where it is necessary to represent Data Attributes. An example of this is the Security Association (SA) Attributes contained in the Transform payload

(described in section 3.6). These Data Attributes are not an ISAKMP payload, but are contained within ISAKMP payloads. The format of the Data Attributes provides the flexibility for representation of many different types of information. There can be multiple Data Attributes within a payload. The length of the Data Attributes will either be 4 octets or defined by the Attribute Length field. This is done using the Attribute Format bit described below. Specific information about the attributes for each domain will be described in a DOI document, e.g. IPSEC DOI [IPDOI].

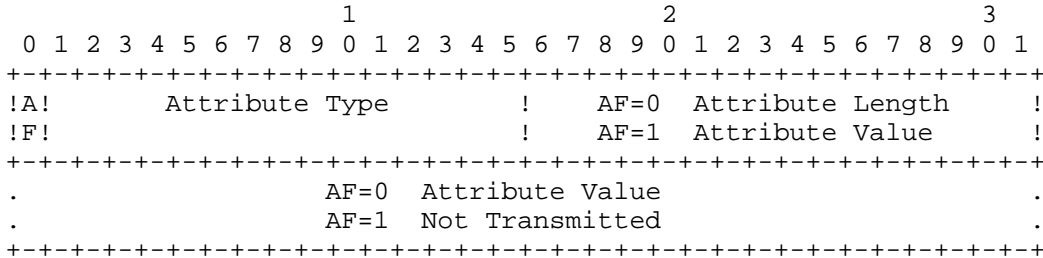

Figure 4: Data Attributes

The Data Attributes fields are defined as follows:

- o Attribute Type (2 octets) - Unique identifier for each type of attribute. These attributes are defined as part of the DOI-specific information.

The most significant bit, or Attribute Format (AF), indicates whether the data attributes follow the Type/Length/Value (TLV) format or a shortened Type/Value (TV) format. If the AF bit is a zero (0), then the Data Attributes are of the Type/Length/Value (TLV) form. If the AF bit is a one (1), then the Data Attributes are of the Type/Value form.

- o Attribute Length (2 octets) - Length in octets of the Attribute Value. When the AF bit is a one (1), the Attribute Value is only 2 octets and the Attribute Length field is not present.
- o Attribute Value (variable length) - Value of the attribute associated with the DOI-specific Attribute Type. If the AF bit is a zero (0), this field has a variable length defined by the Attribute Length field. If the AF bit is a one (1), the Attribute Value has a length of 2 octets.

3.4 Security Association Payload

The Security Association Payload is used to negotiate security attributes and to indicate the Domain of Interpretation (DOI) and Situation under which the negotiation is taking place. Figure 5 shows the format of the Security Association payload.

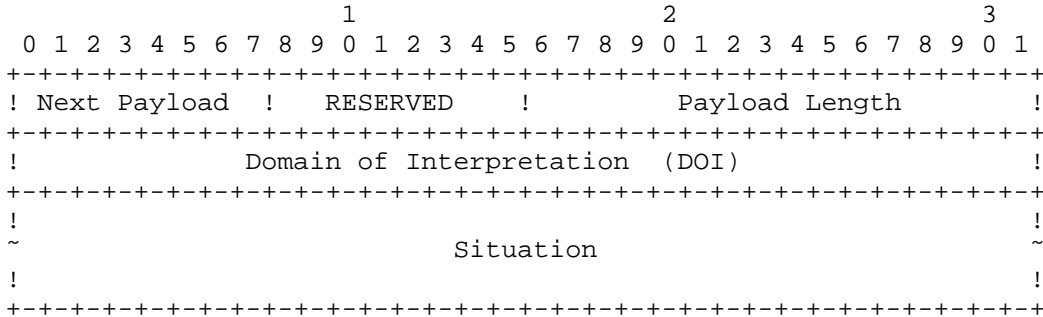

Figure 5: Security Association Payload

- o Next Payload (1 octet) - Identifier for the payload type of the next payload in the message. If the current payload is the last in the message, then this field will be 0. This field MUST NOT contain the values for the Proposal or Transform payloads as they are considered part of the security association negotiation. For example, this field would contain the value "10" (Nonce payload) in the first message of a Base Exchange (see Section 4.4) and the value "0" in the first message of an Identity Protect Exchange (see Section 4.5).
- o RESERVED (1 octet) - Unused, set to 0.
- o Payload Length (2 octets) - Length in octets of the entire Security Association payload, including the SA payload, all Proposal payloads, and all Transform payloads associated with the proposed Security Association.
- o Domain of Interpretation (4 octets) - Identifies the DOI (as described in Section 2.1) under which this negotiation is taking place. The DOI is a 32-bit unsigned integer. A DOI value of 0 during a Phase 1 exchange specifies a Generic ISAKMP SA which can be used for any protocol during the Phase 2 exchange. The necessary SA Attributes are defined in A.4. A DOI value of 1 is assigned to the IPsec DOI [IPDOI]. All other DOI values are reserved to IANA for future use. IANA will not normally assign a DOI value without referencing some public specification, such as

an Internet RFC. Other DOI's can be defined using the description in appendix B. This field MUST be present within the Security Association payload.

- o Situation (variable length) - A DOI-specific field that identifies the situation under which this negotiation is taking place. The Situation is used to make policy decisions regarding the security attributes being negotiated. Specifics for the IETF IP Security DOI Situation are detailed in [IPDOI]. This field MUST be present within the Security Association payload.

3.5 Proposal Payload

The Proposal Payload contains information used during Security Association negotiation. The proposal consists of security mechanisms, or transforms, to be used to secure the communications channel. Figure 6 shows the format of the Proposal Payload. A description of its use can be found in section 4.2.

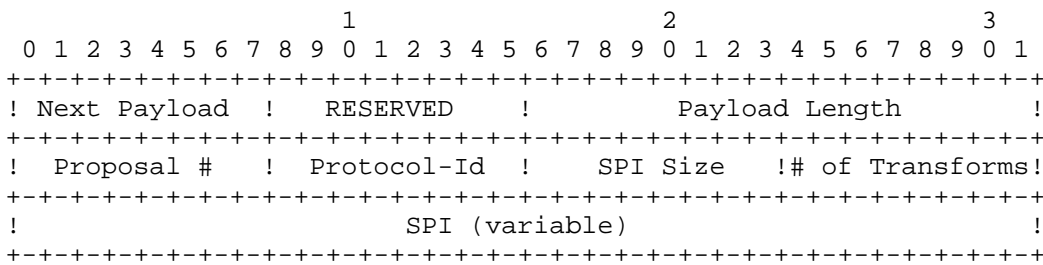

Figure 6: Proposal Payload Format

The Proposal Payload fields are defined as follows:

- o Next Payload (1 octet) - Identifier for the payload type of the next payload in the message. This field MUST only contain the value "2" or "0". If there are additional Proposal payloads in the message, then this field will be 2. If the current Proposal payload is the last within the security association proposal, then this field will be 0.
- o RESERVED (1 octet) - Unused, set to 0.
- o Payload Length (2 octets) - Length in octets of the entire Proposal payload, including generic payload header, the Proposal payload, and all Transform payloads associated with this proposal. In the event there are multiple proposals with the same proposal number (see section 4.2), the Payload Length field

only applies to the current Proposal payload and not to all Proposal payloads.

- o Proposal # (1 octet) - Identifies the Proposal number for the current payload. A description of the use of this field is found in section 4.2.
- o Protocol-Id (1 octet) - Specifies the protocol identifier for the current negotiation. Examples might include IPSEC ESP, IPSEC AH, OSPF, TLS, etc.
- o SPI Size (1 octet) - Length in octets of the SPI as defined by the Protocol-Id. In the case of ISAKMP, the Initiator and Responder cookie pair from the ISAKMP Header is the ISAKMP SPI, therefore, the SPI Size is irrelevant and MAY be from zero (0) to sixteen (16). If the SPI Size is non-zero, the content of the SPI field MUST be ignored. If the SPI Size is not a multiple of 4 octets it will have some impact on the SPI field and the alignment of all payloads in the message. The Domain of Interpretation (DOI) will dictate the SPI Size for other protocols.
- o # of Transforms (1 octet) - Specifies the number of transforms for the Proposal. Each of these is contained in a Transform payload.
- o SPI (variable) - The sending entity's SPI. In the event the SPI Size is not a multiple of 4 octets, there is no padding applied to the payload, however, it can be applied at the end of the message.

The payload type for the Proposal Payload is two (2).

3.6 Transform Payload

The Transform Payload contains information used during Security Association negotiation. The Transform payload consists of a specific security mechanism, or transforms, to be used to secure the communications channel. The Transform payload also contains the security association attributes associated with the specific transform. These SA attributes are DOI-specific. Figure 7 shows the format of the Transform Payload. A description of its use can be found in section 4.2.

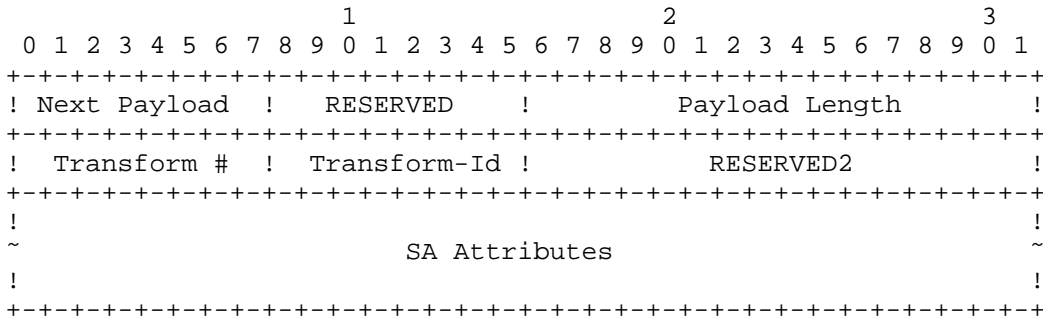

Figure 7: Transform Payload Format

The Transform Payload fields are defined as follows:

- o Next Payload (1 octet) - Identifier for the payload type of the next payload in the message. This field MUST only contain the value "3" or "0". If there are additional Transform payloads in the proposal, then this field will be 3. If the current Transform payload is the last within the proposal, then this field will be 0.
- o RESERVED (1 octet) - Unused, set to 0.
- o Payload Length (2 octets) - Length in octets of the current payload, including the generic payload header, Transform values, and all SA Attributes.
- o Transform # (1 octet) - Identifies the Transform number for the current payload. If there is more than one transform proposed for a specific protocol within the Proposal payload, then each Transform payload has a unique Transform number. A description of the use of this field is found in section 4.2.
- o Transform-Id (1 octet) - Specifies the Transform identifier for the protocol within the current proposal. These transforms are defined by the DOI and are dependent on the protocol being negotiated.
- o RESERVED2 (2 octets) - Unused, set to 0.
- o SA Attributes (variable length) - This field contains the security association attributes as defined for the transform given in the Transform-Id field. The SA Attributes SHOULD be represented using the Data Attributes format described in section 3.3. If the SA Attributes are not aligned on 4-byte boundaries,

then subsequent payloads will not be aligned and any padding will be added at the end of the message to make the message 4-octet aligned.

The payload type for the Transform Payload is three (3).

3.7 Key Exchange Payload

The Key Exchange Payload supports a variety of key exchange techniques. Example key exchanges are Oakley [Oakley], Diffie-Hellman, the enhanced Diffie-Hellman key exchange described in X9.42 [ANSI], and the RSA-based key exchange used by PGP. Figure 8 shows the format of the Key Exchange payload.

The Key Exchange Payload fields are defined as follows:

- o Next Payload (1 octet) - Identifier for the payload type of the nextpayload in the message. If the current payload is the last in the message, then this field will be 0.

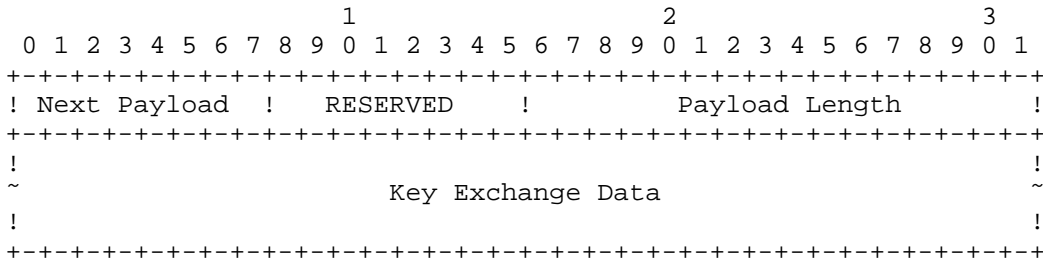

Figure 8: Key Exchange Payload Format

- o RESERVED (1 octet) - Unused, set to 0.
- o Payload Length (2 octets) - Length in octets of the current payload, including the generic payload header.
- o Key Exchange Data (variable length) - Data required to generate a session key. The interpretation of this data is specified by the DOI and the associated Key Exchange algorithm. This field may also contain pre-placed key indicators.

The payload type for the Key Exchange Payload is four (4).

3.8 Identification Payload

The Identification Payload contains DOI-specific data used to exchange identification information. This information is used for determining the identities of communicating peers and may be used for determining authenticity of information. Figure 9 shows the format of the Identification Payload.

The Identification Payload fields are defined as follows:

- o Next Payload (1 octet) - Identifier for the payload type of the next payload in the message. If the current payload is the last in the message, then this field will be 0.
- o RESERVED (1 octet) - Unused, set to 0.
- o Payload Length (2 octets) - Length in octets of the current payload, including the generic payload header.
- o ID Type (1 octet) - Specifies the type of Identification being used.

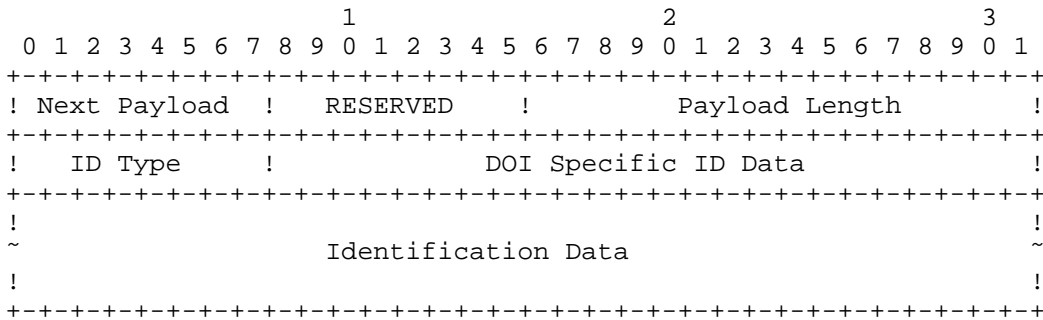

Figure 9: Identification Payload Format

This field is DOI-dependent.

- o DOI Specific ID Data (3 octets) - Contains DOI specific Identification data. If unused, then this field MUST be set to 0.
- o Identification Data (variable length) - Contains identity information. The values for this field are DOI-specific and the format is specified by the ID Type field. Specific details for the IETF IP Security DOI Identification Data are detailed in [IPDOI].

The payload type for the Identification Payload is five (5).

3.9 Certificate Payload

The Certificate Payload provides a means to transport certificates or other certificate-related information via ISAKMP and can appear in any ISAKMP message. Certificate payloads SHOULD be included in an exchange whenever an appropriate directory service (e.g. Secure DNS [DNSSEC]) is not available to distribute certificates. The Certificate payload MUST be accepted at any point during an exchange. Figure 10 shows the format of the Certificate Payload.

NOTE: Certificate types and formats are not generally bound to a DOI - it is expected that there will only be a few certificate types, and that most DOIs will accept all of these types.

The Certificate Payload fields are defined as follows:

- o Next Payload (1 octet) - Identifier for the payload type of the next payload in the message. If the current payload is the last in the message, then this field will be 0.

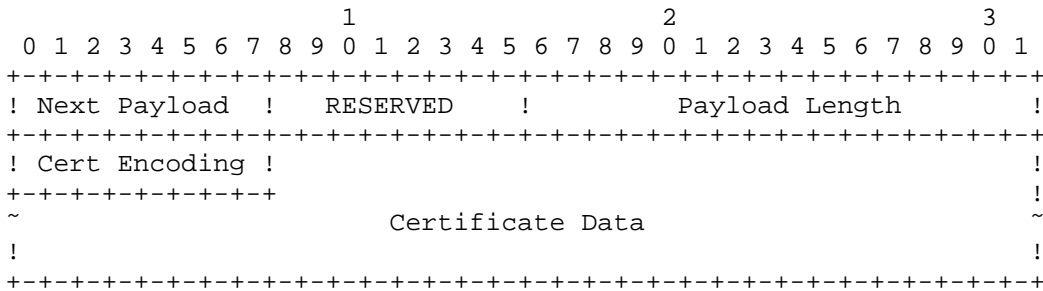

Figure 10: Certificate Payload Format

- o RESERVED (1 octet) - Unused, set to 0.
- o Payload Length (2 octets) - Length in octets of the current payload, including the generic payload header.
- o Certificate Encoding (1 octet) - This field indicates the type of certificate or certificate-related information contained in the Certificate Data field.

Certificate Type	Value
NONE	0
PKCS #7 wrapped X.509 certificate	1
PGP Certificate	2
DNS Signed Key	3
X.509 Certificate - Signature	4
X.509 Certificate - Key Exchange	5
Kerberos Tokens	6
Certificate Revocation List (CRL)	7
Authority Revocation List (ARL)	8
SPKI Certificate	9
X.509 Certificate - Attribute	10
RESERVED	11 - 255

- o Certificate Data (variable length) - Actual encoding of certificate data. The type of certificate is indicated by the Certificate Encoding field.

The payload type for the Certificate Payload is six (6).

3.10 Certificate Request Payload

The Certificate Request Payload provides a means to request certificates via ISAKMP and can appear in any message. Certificate Request payloads SHOULD be included in an exchange whenever an appropriate directory service (e.g. Secure DNS [DNSSEC]) is not available to distribute certificates. The Certificate Request payload MUST be accepted at any point during the exchange. The responder to the Certificate Request payload MUST send its certificate, if certificates are supported, based on the values contained in the payload. If multiple certificates are required, then multiple Certificate Request payloads SHOULD be transmitted. Figure 11 shows the format of the Certificate Request Payload.

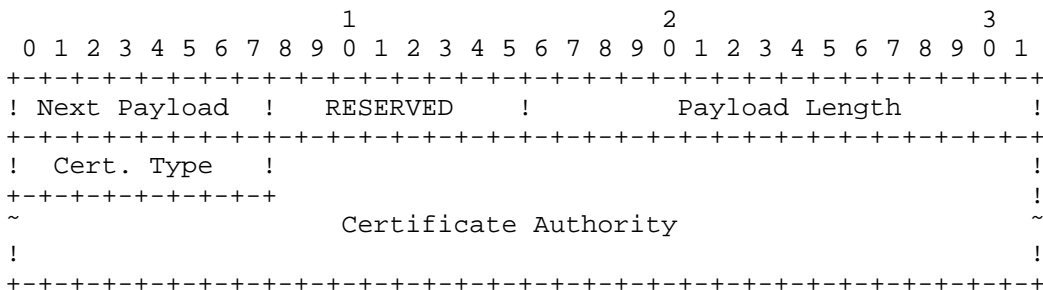

Figure 11: Certificate Request Payload Format

The Certificate Payload fields are defined as follows:

- o Next Payload (1 octet) - Identifier for the payload type of the next payload in the message. If the current payload is the last in the message, then this field will be 0.
- o RESERVED (1 octet) - Unused, set to 0.
- o Payload Length (2 octets) - Length in octets of the current payload, including the generic payload header.
- o Certificate Type (1 octet) - Contains an encoding of the type of certificate requested. Acceptable values are listed in section 3.9.
- o Certificate Authority (variable length) - Contains an encoding of an acceptable certificate authority for the type of certificate requested. As an example, for an X.509 certificate this field would contain the Distinguished Name encoding of the Issuer Name of an X.509 certificate authority acceptable to the sender of this payload. This would be included to assist the responder in determining how much of the certificate chain would need to be sent in response to this request. If there is no specific certificate authority requested, this field SHOULD not be included.

The payload type for the Certificate Request Payload is seven (7).

3.11 Hash Payload

The Hash Payload contains data generated by the hash function (selected during the SA establishment exchange), over some part of the message and/or ISAKMP state. This payload may be used to verify the integrity of the data in an ISAKMP message or for authentication of the negotiating entities. Figure 12 shows the format of the Hash Payload.

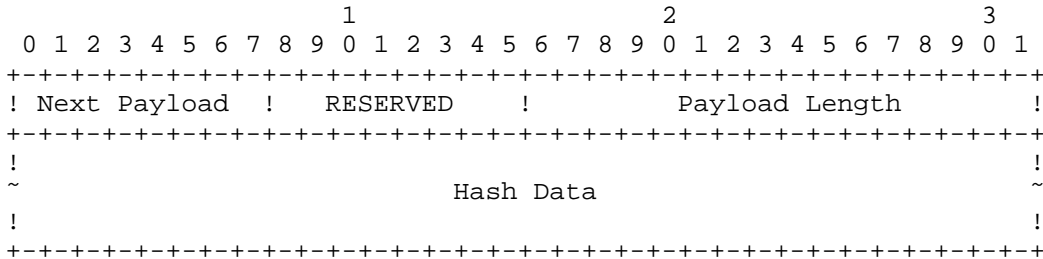

Figure 12: Hash Payload Format

The Hash Payload fields are defined as follows:

- o Next Payload (1 octet) - Identifier for the payload type of the next payload in the message. If the current payload is the last in the message, then this field will be 0.
- o RESERVED (1 octet) - Unused, set to 0.
- o Payload Length (2 octets) - Length in octets of the current payload, including the generic payload header.
- o Hash Data (variable length) - Data that results from applying the hash routine to the ISAKMP message and/or state.

3.12 Signature Payload

The Signature Payload contains data generated by the digital signature function (selected during the SA establishment exchange), over some part of the message and/or ISAKMP state. This payload is used to verify the integrity of the data in the ISAKMP message, and may be of use for non-repudiation services. Figure 13 shows the format of the Signature Payload.

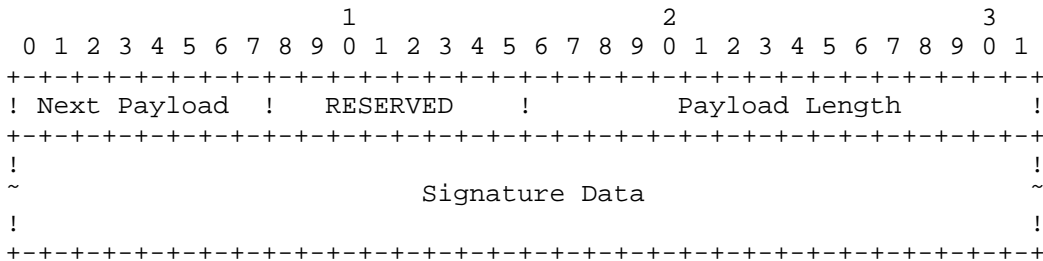

Figure 13: Signature Payload Format

The Signature Payload fields are defined as follows:

- o Next Payload (1 octet) - Identifier for the payload type of the next payload in the message. If the current payload is the last in the message, then this field will be 0.
- o RESERVED (1 octet) - Unused, set to 0.
- o Payload Length (2 octets) - Length in octets of the current payload, including the generic payload header.
- o Signature Data (variable length) - Data that results from applying the digital signature function to the ISAKMP message and/or state.

The payload type for the Signature Payload is nine (9).

3.13 Nonce Payload

The Nonce Payload contains random data used to guarantee liveness during an exchange and protect against replay attacks. Figure 14 shows the format of the Nonce Payload. If nonces are used by a particular key exchange, the use of the Nonce payload will be dictated by the key exchange. The nonces may be transmitted as part of the key exchange data, or as a separate payload. However, this is defined by the key exchange, not by ISAKMP.

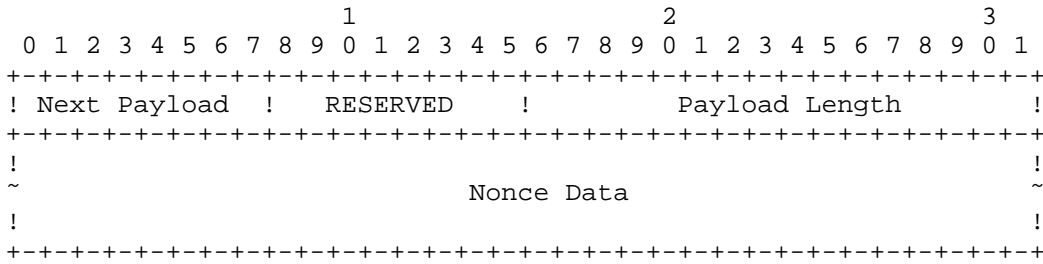

Figure 14: Nonce Payload Format

The Nonce Payload fields are defined as follows:

- o Next Payload (1 octet) - Identifier for the payload type of the next payload in the message. If the current payload is the last in the message, then this field will be 0.
- o RESERVED (1 octet) - Unused, set to 0.
- o Payload Length (2 octets) - Length in octets of the current payload, including the generic payload header.
- o Nonce Data (variable length) - Contains the random data generated by the transmitting entity.

The payload type for the Nonce Payload is ten (10).

3.14 Notification Payload

The Notification Payload can contain both ISAKMP and DOI-specific data and is used to transmit informational data, such as error conditions, to an ISAKMP peer. It is possible to send multiple Notification payloads in a single ISAKMP message. Figure 15 shows the format of the Notification Payload.

Notification which occurs during, or is concerned with, a Phase 1 negotiation is identified by the Initiator and Responder cookie pair in the ISAKMP Header. The Protocol Identifier, in this case, is ISAKMP and the SPI value is 0 because the cookie pair in the ISAKMP Header identifies the ISAKMP SA. If the notification takes place prior to the completed exchange of keying information, then the notification will be unprotected.

Notification which occurs during, or is concerned with, a Phase 2 negotiation is identified by the Initiator and Responder cookie pair in the ISAKMP Header and the Message ID and SPI associated with the current negotiation. One example for this type of notification is to indicate why a proposal was rejected.

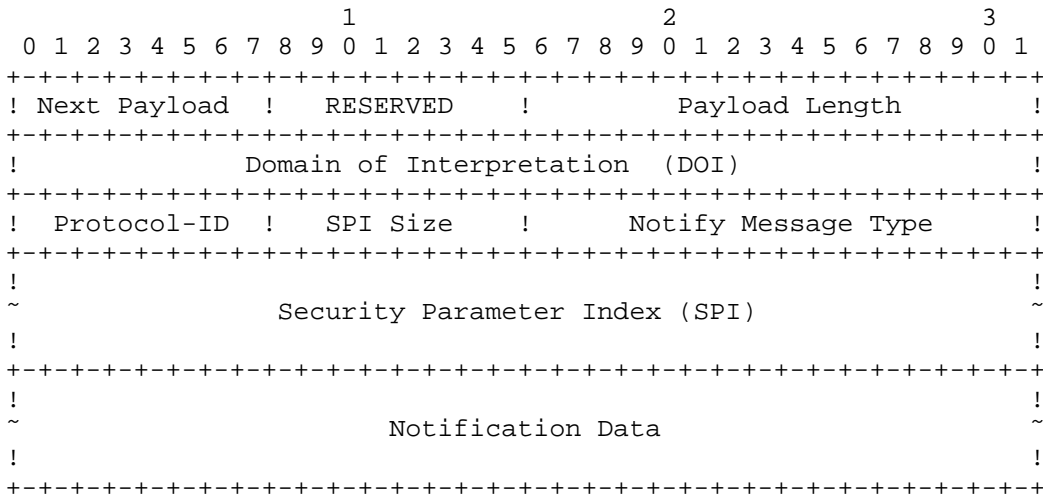

Figure 15: Notification Payload Format

The Notification Payload fields are defined as follows:

- o Next Payload (1 octet) - Identifier for the payload type of the next payload in the message. If the current payload is the last in the message, then this field will be 0.
- o RESERVED (1 octet) - Unused, set to 0.
- o Payload Length (2 octets) - Length in octets of the current payload, including the generic payload header.
- o Domain of Interpretation (4 octets) - Identifies the DOI (as described in Section 2.1) under which this notification is taking place. For ISAKMP this value is zero (0) and for the IPSEC DOI it is one (1). Other DOI's can be defined using the description in appendix B.
- o Protocol-Id (1 octet) - Specifies the protocol identifier for the current notification. Examples might include ISAKMP, IPSEC ESP, IPSEC AH, OSPF, TLS, etc.

- o SPI Size (1 octet) - Length in octets of the SPI as defined by the Protocol-Id. In the case of ISAKMP, the Initiator and Responder cookie pair from the ISAKMP Header is the ISAKMP SPI, therefore, the SPI Size is irrelevant and MAY be from zero (0) to sixteen (16). If the SPI Size is non-zero, the content of the SPI field MUST be ignored. The Domain of Interpretation (DOI) will dictate the SPI Size for other protocols.
- o Notify Message Type (2 octets) - Specifies the type of notification message (see section 3.14.1). Additional text, if specified by the DOI, is placed in the Notification Data field.
- o SPI (variable length) - Security Parameter Index. The receiving entity's SPI. The use of the SPI field is described in section 2.4. The length of this field is determined by the SPI Size field and is not necessarily aligned to a 4 octet boundary.
- o Notification Data (variable length) - Informational or error data transmitted in addition to the Notify Message Type. Values for this field are DOI-specific.

The payload type for the Notification Payload is eleven (11).

3.14.1 Notify Message Types

Notification information can be error messages specifying why an SA could not be established. It can also be status data that a process managing an SA database wishes to communicate with a peer process. For example, a secure front end or security gateway may use the Notify message to synchronize SA communication. The table below lists the Notification messages and their corresponding values. Values in the Private Use range are expected to be DOI-specific values.

NOTIFY MESSAGES - ERROR TYPES

Errors	Value
INVALID-PAYLOAD-TYPE	1
DOI-NOT-SUPPORTED	2
SITUATION-NOT-SUPPORTED	3
INVALID-COOKIE	4
INVALID-MAJOR-VERSION	5
INVALID-MINOR-VERSION	6
INVALID-EXCHANGE-TYPE	7
INVALID-FLAGS	8
INVALID-MESSAGE-ID	9
INVALID-PROTOCOL-ID	10
INVALID-SPI	11

INVALID-TRANSFORM-ID	12
ATTRIBUTES-NOT-SUPPORTED	13
NO-PROPOSAL-CHOSEN	14
BAD-PROPOSAL-SYNTAX	15
PAYLOAD-MALFORMED	16
INVALID-KEY-INFORMATION	17
INVALID-ID-INFORMATION	18
INVALID-CERT-ENCODING	19
INVALID-CERTIFICATE	20
CERT-TYPE-UNSUPPORTED	21
INVALID-CERT-AUTHORITY	22
INVALID-HASH-INFORMATION	23
AUTHENTICATION-FAILED	24
INVALID-SIGNATURE	25
ADDRESS-NOTIFICATION	26
NOTIFY-SA-LIFETIME	27
CERTIFICATE-UNAVAILABLE	28
UNSUPPORTED-EXCHANGE-TYPE	29
UNEQUAL-PAYLOAD-LENGTHS	30
RESERVED (Future Use)	31 - 8191
Private Use	8192 - 16383

NOTIFY MESSAGES - STATUS TYPES

Status	Value
CONNECTED	16384
RESERVED (Future Use)	16385 - 24575
DOI-specific codes	24576 - 32767
Private Use	32768 - 40959
RESERVED (Future Use)	40960 - 65535

3.15 Delete Payload

The Delete Payload contains a protocol-specific security association identifier that the sender has removed from its security association database and is, therefore, no longer valid. Figure 16 shows the format of the Delete Payload. It is possible to send multiple SPIs in a Delete payload, however, each SPI MUST be for the same protocol. Mixing of Protocol Identifiers MUST NOT be performed with the Delete payload.

Deletion which is concerned with an ISAKMP SA will contain a Protocol-Id of ISAKMP and the SPIs are the initiator and responder cookies from the ISAKMP Header. Deletion which is concerned with a Protocol SA, such as ESP or AH, will contain the Protocol-Id of that protocol (e.g. ESP, AH) and the SPI is the sending entity's SPI(s).

NOTE: The Delete Payload is not a request for the responder to delete an SA, but an advisory from the initiator to the responder. If the responder chooses to ignore the message, the next communication from the responder to the initiator, using that security association, will fail. A responder is not expected to acknowledge receipt of a Delete payload.

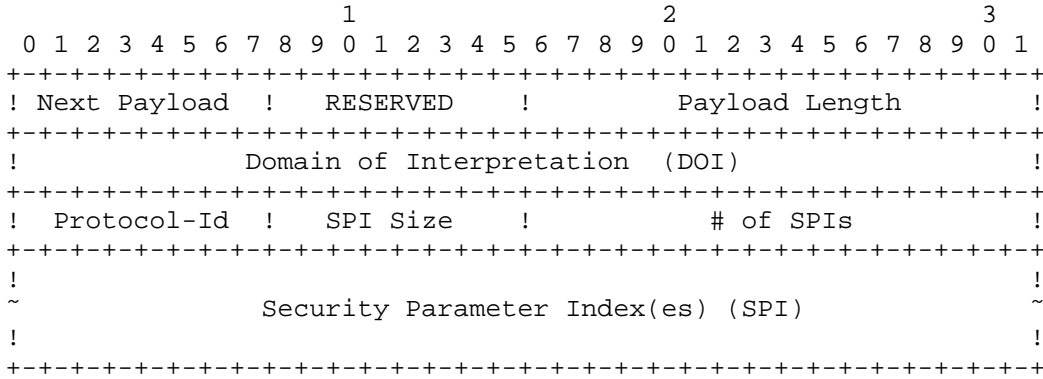

Figure 16: Delete Payload Format

The Delete Payload fields are defined as follows:

- o Next Payload (1 octet) - Identifier for the payload type of the next payload in the message. If the current payload is the last in the message, then this field will be 0.
- o RESERVED (1 octet) - Unused, set to 0.
- o Payload Length (2 octets) - Length in octets of the current payload, including the generic payload header.
- o Domain of Interpretation (4 octets) - Identifies the DOI (as described in Section 2.1) under which this deletion is taking place. For ISAKMP this value is zero (0) and for the IPSEC DOI it is one (1). Other DOI's can be defined using the description in appendix B.
- o Protocol-Id (1 octet) - ISAKMP can establish security associations for various protocols, including ISAKMP and IPSEC. This field identifies which security association database to apply the delete request.

- o SPI Size (1 octet) - Length in octets of the SPI as defined by the Protocol-Id. In the case of ISAKMP, the Initiator and Responder cookie pair is the ISAKMP SPI. In this case, the SPI Size would be 16 octets for each SPI being deleted.
- o # of SPIs (2 octets) - The number of SPIs contained in the Delete payload. The size of each SPI is defined by the SPI Size field.
- o Security Parameter Index(es) (variable length) - Identifies the specific security association(s) to delete. Values for this field are DOI and protocol specific. The length of this field is determined by the SPI Size and # of SPIs fields.

The payload type for the Delete Payload is twelve (12).

3.16 Vendor ID Payload

The Vendor ID Payload contains a vendor defined constant. The constant is used by vendors to identify and recognize remote instances of their implementations. This mechanism allows a vendor to experiment with new features while maintaining backwards compatibility. This is not a general extension facility of ISAKMP. Figure 17 shows the format of the Vendor ID Payload.

The Vendor ID payload is not an announcement from the sender that it will send private payload types. A vendor sending the Vendor ID MUST not make any assumptions about private payloads that it may send unless a Vendor ID is received as well. Multiple Vendor ID payloads MAY be sent. An implementation is NOT REQUIRED to understand any Vendor ID payloads. An implementation is NOT REQUIRED to send any Vendor ID payload at all. If a private payload was sent without prior agreement to send it, a compliant implementation may reject a proposal with a notify message of type INVALID-PAYLOAD-TYPE.

If a Vendor ID payload is sent, it MUST be sent during the Phase 1 negotiation. Reception of a familiar Vendor ID payload in the Phase 1 negotiation allows an implementation to make use of Private USE payload numbers (128-255), described in section 3.1 for vendor specific extensions during Phase 2 negotiations. The definition of "familiar" is left to implementations to determine. Some vendors may wish to implement another vendor's extension prior to standardization. However, this practice SHOULD not be widespread and vendors should work towards standardization instead.

The vendor defined constant MUST be unique. The choice of hash and text to hash is left to the vendor to decide. As an example, vendors could generate their vendor id by taking a plain (non-keyed) hash of a string containing the product name, and the version of the product.

A hash is used instead of a vendor registry to avoid local cryptographic policy problems with having a list of "approved" products, to keep away from maintaining a list of vendors, and to allow classified products to avoid having to appear on any list. For instance:

"Example Company IPsec. Version 97.1"

(not including the quotes) has MD5 hash: 48544f9b1fe662af98b9b39e50c01a5a, when using MD5file. Vendors may include all of the hash, or just a portion of it, as the payload length will bound the data. There are no security implications of this hash, so its choice is arbitrary.

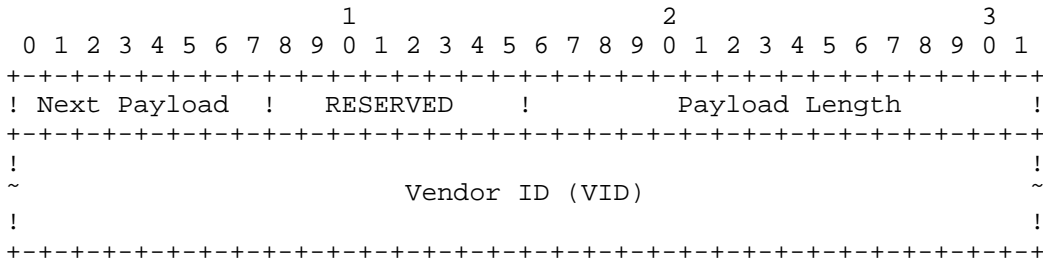

Figure 17: Vendor ID Payload Format

The Vendor ID Payload fields are defined as follows:

- o Next Payload (1 octet) - Identifier for the payload type of the next payload in the message. If the current payload is the last in the message, then this field will be 0.
- o RESERVED (1 octet) - Unused, set to 0.
- o Payload Length (2 octets) - Length in octets of the current payload, including the generic payload header.
- o Vendor ID (variable length) - Hash of the vendor string plus version (as described above).

The payload type for the Vendor ID Payload is thirteen (13).

4 ISAKMP Exchanges

ISAKMP supplies the basic syntax of a message exchange. The basic building blocks for ISAKMP messages are the payload types described in section 3. This section describes the procedures for SA

establishment and SA modification, followed by a default set of exchanges that MAY be used for initial interoperability. Other exchanges will be defined depending on the DOI and key exchange. [IPDOI] and [IKE] are examples of how this is achieved. Appendix B explains the procedures for accomplishing these additions.

4.1 ISAKMP Exchange Types

ISAKMP allows the creation of exchanges for the establishment of Security Associations and keying material. There are currently five default Exchange Types defined for ISAKMP. Sections 4.4 through 4.8 describe these exchanges. Exchanges define the content and ordering of ISAKMP messages during communications between peers. Most exchanges will include all the basic payload types - SA, KE, ID, SIG - and may include others. The primary difference between exchange types is the ordering of the messages and the payload ordering within each message. While the ordering of payloads within messages is not mandated, for processing efficiency it is RECOMMENDED that the Security Association payload be the first payload within an exchange. Processing of each payload within an exchange is described in section 5.

Sections 4.4 through 4.8 provide a default set of ISAKMP exchanges. These exchanges provide different security protection for the exchange itself and information exchanged. The diagrams in each of the following sections show the message ordering for each exchange type as well as the payloads included in each message, and provide basic notes describing what has happened after each message exchange. None of the examples include any "optional payloads", like certificate and certificate request. Additionally, none of the examples include an initial exchange of ISAKMP Headers (containing initiator and responder cookies) which would provide protection against clogging (see section 2.5.3).

The defined exchanges are not meant to satisfy all DOI and key exchange protocol requirements. If the defined exchanges meet the DOI requirements, then they can be used as outlined. If the defined exchanges do not meet the security requirements defined by the DOI, then the DOI MUST specify new exchange type(s) and the valid sequences of payloads that make up a successful exchange, and how to build and interpret those payloads. All ISAKMP implementations MUST implement the Informational Exchange and SHOULD implement the other four exchanges. However, this is dependent on the definition of the DOI and associated key exchange protocols.

As discussed above, these exchange types can be used in either phase of negotiation. However, they may provide different security properties in each of the phases. With each of these exchanges, the combination of cookies and SPI fields identifies whether this exchange is being used in the first or second phase of a negotiation.

4.1.1 Notation

The following notation is used to describe the ISAKMP exchange types, shown in the next section, with the message formats and associated payloads:

HDR is an ISAKMP header whose exchange type defines the payload orderings

SA is an SA negotiation payload with one or more Proposal and Transform payloads. An initiator MAY provide multiple proposals for negotiation; a responder MUST reply with only one.

KE is the key exchange payload.

IDx is the identity payload for "x". x can be: "ii" or "ir" for the ISAKMP initiator and responder, respectively, or x can be: "ui", "ur" (when the ISAKMP daemon is a proxy negotiator), for the user initiator and responder, respectively.

HASH is the hash payload.

SIG is the signature payload. The data to sign is exchange-specific.

AUTH is a generic authentication mechanism, such as HASH or SIG.

NONCE is the nonce payload.

'*' signifies payload encryption after the ISAKMP header. This encryption MUST begin immediately after the ISAKMP header and all payloads following the ISAKMP header MUST be encrypted.

=> signifies "initiator to responder" communication

<= signifies "responder to initiator" communication

4.2 Security Association Establishment

The Security Association, Proposal, and Transform payloads are used to build ISAKMP messages for the negotiation and establishment of SAs. An SA establishment message consists of a single SA payload followed by at least one, and possibly many, Proposal payloads and at least one, and possibly many, Transform payloads associated with each Proposal payload. Because these payloads are considered together, the SA payload will point to any following payloads and not to the Proposal payload included with the SA payload. The SA Payload contains the DOI and Situation for the proposed SA. Each Proposal payload contains a Security Parameter Index (SPI) and ensures that the SPI is associated with the Protocol-Id in accordance with the Internet Security Architecture [SEC-ARCH]. Proposal payloads may or may not have the same SPI, as this is implementation dependent. Each

Transform Payload contains the specific security mechanisms to be used for the designated protocol. It is expected that the Proposal and Transform payloads will be used only during SA establishment negotiation. The creation of payloads for security association negotiation and establishment described here in this section are applicable for all ISAKMP exchanges described later in sections 4.4 through 4.8. The examples shown in 4.2.1 contain only the SA, Proposal, and Transform payloads and do not contain other payloads that might exist for a given ISAKMP exchange.

The Proposal payload provides the initiating entity with the capability to present to the responding entity the security protocols and associated security mechanisms for use with the security association being negotiated. If the SA establishment negotiation is for a combined protection suite consisting of multiple protocols, then there MUST be multiple Proposal payloads each with the same Proposal number. These proposals MUST be considered as a unit and MUST NOT be separated by a proposal with a different proposal number. The use of the same Proposal number in multiple Proposal payloads provides a logical AND operation, i.e. Protocol 1 AND Protocol 2. The first example below shows an ESP AND AH protection suite. If the SA establishment negotiation is for different protection suites, then there MUST be multiple Proposal payloads each with a monotonically increasing Proposal number. The different proposals MUST be presented in the initiator's preference order. The use of different Proposal numbers in multiple Proposal payloads provides a logical OR operation, i.e. Proposal 1 OR Proposal 2, where each proposal may have more than one protocol. The second example below shows either an AH AND ESP protection suite OR just an ESP protection suite. Note that the Next Payload field of the Proposal payload points to another Proposal payload (if it exists). The existence of a Proposal payload implies the existence of one or more Transform payloads.

The Transform payload provides the initiating entity with the capability to present to the responding entity multiple mechanisms, or transforms, for a given protocol. The Proposal payload identifies a Protocol for which services and mechanisms are being negotiated. The Transform payload allows the initiating entity to present several possible supported transforms for that proposed protocol. There may be several transforms associated with a specific Proposal payload each identified in a separate Transform payload. The multiple transforms MUST be presented with monotonically increasing numbers in the initiator's preference order. The receiving entity MUST select a single transform for each protocol in a proposal or reject the entire proposal. The use of the Transform number in multiple Transform payloads provides a second level OR operation, i.e. Transform 1 OR Transform 2 OR Transform 3. Example 1 below shows two possible transforms for ESP and a single transform for AH. Example 2 below

shows one transform for AH AND one transform for ESP OR two transforms for ESP alone. Note that the Next Payload field of the Transform payload points to another Transform payload or 0. The Proposal payload delineates the different proposals.

When responding to a Security Association payload, the responder MUST send a Security Association payload with the selected proposal, which may consist of multiple Proposal payloads and their associated Transform payloads. Each of the Proposal payloads MUST contain a single Transform payload associated with the Protocol. The responder SHOULD retain the Proposal # field in the Proposal payload and the Transform # field in each Transform payload of the selected Proposal. Retention of Proposal and Transform numbers should speed the initiator's protocol processing by negating the need to compare the responder's selection with every offered option. These values enable the initiator to perform the comparison directly and quickly. The initiator MUST verify that the Security Association payload received from the responder matches one of the proposals sent initially.

4.2.1 Security Association Establishment Examples

This example shows a Proposal for a combined protection suite with two different protocols. The first protocol is presented with two transforms supported by the proposer. The second protocol is presented with a single transform. An example for this proposal might be: Protocol 1 is ESP with Transform 1 as 3DES and Transform 2 as DES AND Protocol 2 is AH with Transform 1 as SHA. The responder MUST select from the two transforms proposed for ESP. The resulting protection suite will be either (1) 3DES AND SHA OR (2) DES AND SHA, depending on which ESP transform was selected by the responder. Note this example is shown using the Base Exchange.

```

          1                2                3
    0 1 2 3 4 5 6 7 8 9 0 1 2 3 4 5 6 7 8 9 0 1 2 3 4 5 6 7 8 9 0 1
    /+-----+-----+-----+-----+-----+-----+-----+-----+
    / ! NP = Nonce      ! RESERVED      ! Payload Length      !
    / +-----+-----+-----+-----+-----+-----+-----+-----+
SA Pay !                               Domain of Interpretation (DOI) !
    \ +-----+-----+-----+-----+-----+-----+-----+-----+
    \ !                               Situation                    !
    >+-----+-----+-----+-----+-----+-----+-----+-----+
    / ! NP = Proposal ! RESERVED      ! Payload Length      !
    / +-----+-----+-----+-----+-----+-----+-----+-----+
Prop 1 ! Proposal # = 1! Protocol-Id ! SPI Size  !# of Trans. = 2!
Prot 1 +-----+-----+-----+-----+-----+-----+-----+-----+
    \ !                               SPI (variable)            !
    >+-----+-----+-----+-----+-----+-----+-----+-----+
    / ! NP = Transform! RESERVED      ! Payload Length      !

```



```

/ +-----+
Tran 1 ! Transform # 1 ! Transform ID ! RESERVED2 !
\ +-----+
  \ !
    >+-----+
  / ! NP = 0 ! RESERVED ! Payload Length !
  / +-----+
Tran 2 ! Transform # 2 ! Transform ID ! RESERVED2 !
\ +-----+
  \ !
    >+-----+
  / ! NP = 0 ! RESERVED ! Payload Length !
  / +-----+
Prop 1 ! Proposal # = 1! Protocol ID ! SPI Size !# of Trans. = 1!
Prot 2 +-----+
  \ !
    >+-----+
  / ! NP = 0 ! RESERVED ! Payload Length !
  / +-----+
Tran 1 ! Transform # 1 ! Transform ID ! RESERVED2 !
\ +-----+
  \ !
    >+-----+

```

This second example shows a Proposal for two different protection suites. The SA Payload was omitted for space reasons. The first protection suite is presented with one transform for the first protocol and one transform for the second protocol. The second protection suite is presented with two transforms for a single protocol. An example for this proposal might be: Proposal 1 with Protocol 1 as AH with Transform 1 as MD5 AND Protocol 2 as ESP with Transform 1 as 3DES. This is followed by Proposal 2 with Protocol 1 as ESP with Transform 1 as DES and Transform 2 as 3DES. The responder MUST select from the two different proposals. If the second Proposal is selected, the responder MUST select from the two transforms for ESP. The resulting protection suite will be either (1) MD5 AND 3DES OR the selection between (2) DES OR (3) 3DES.

```

          1          2          3
    0 1 2 3 4 5 6 7 8 9 0 1 2 3 4 5 6 7 8 9 0 1 2 3 4 5 6 7 8 9 0 1
/ +-----+
/ ! NP = Proposal ! RESERVED ! Payload Length !
/ +-----+
Prop 1 ! Proposal # = 1! Protocol ID ! SPI Size !# of Trans. = 1!
Prot 1 +-----+
  \ !
    >+-----+
  / ! NP = 0 ! RESERVED ! Payload Length !

```

```

/ +-----+
Tran 1 ! Transform # 1 ! Transform ID ! RESERVED2 !
\ +-----+
  \ ! SA Attributes !
  >+-----+
/ ! NP = Proposal ! RESERVED ! Payload Length !
/ +-----+
Prop 1 ! Proposal # = 1! Protocol ID ! SPI Size !# of Trans. = 1!
Prot 2 +-----+
  \ ! SPI (variable) !
  >+-----+
/ ! NP = 0 ! RESERVED ! Payload Length !
/ +-----+
Tran 1 ! Transform # 1 ! Transform ID ! RESERVED2 !
\ +-----+
  \ ! SA Attributes !
  >+-----+
/ ! NP = 0 ! RESERVED ! Payload Length !
/ +-----+
Prop 2 ! Proposal # = 2! Protocol ID ! SPI Size !# of Trans. = 2!
Prot 1 +-----+
  \ ! SPI (variable) !
  >+-----+
/ ! NP = Transform! RESERVED ! Payload Length !
/ +-----+
Tran 1 ! Transform # 1 ! Transform ID ! RESERVED2 !
\ +-----+
  \ ! SA Attributes !
  >+-----+
/ ! NP = 0 ! RESERVED ! Payload Length !
/ +-----+
Tran 2 ! Transform # 2 ! Transform ID ! RESERVED2 !
\ +-----+
  \ ! SA Attributes !
  >+-----+

```

4.3 Security Association Modification

Security Association modification within ISAKMP is accomplished by creating a new SA and initiating communications using that new SA. Deletion of the old SA can be done anytime after the new SA is established. Deletion of the old SA is dependent on local security policy. Modification of SAs by using a "Create New SA followed by Delete Old SA" method is done to avoid potential vulnerabilities in synchronizing modification of existing SA attributes. The procedure for creating new SAs is outlined in section 4.2. The procedure for deleting SAs is outlined in section 5.15.

Modification of an ISAKMP SA (phase 1 negotiation) follows the same procedure as creation of an ISAKMP SA. There is no relationship between the two SAs and the initiator and responder cookie pairs SHOULD be different, as outlined in section 2.5.3.

Modification of a Protocol SA (phase 2 negotiation) follows the same procedure as creation of a Protocol SA. The creation of a new SA is protected by the existing ISAKMP SA. There is no relationship between the two Protocol SAs. A protocol implementation SHOULD begin using the newly created SA for outbound traffic and SHOULD continue to support incoming traffic on the old SA until it is deleted or until traffic is received under the protection of the newly created SA. As stated previously in this section, deletion of an old SA is then dependent on local security policy.

4.4 Base Exchange

The Base Exchange is designed to allow the Key Exchange and Authentication related information to be transmitted together. Combining the Key Exchange and Authentication-related information into one message reduces the number of round-trips at the expense of not providing identity protection. Identity protection is not provided because identities are exchanged before a common shared secret has been established and, therefore, encryption of the identities is not possible. The following diagram shows the messages with the possible payloads sent in each message and notes for an example of the Base Exchange.

BASE EXCHANGE

#	Initiator	Direction	Responder	NOTE
(1)	HDR; SA; NONCE	=>		Begin ISAKMP-SA or Proxy negotiation
(2)		<=	HDR; SA; NONCE	Basic SA agreed upon
(3)	HDR; KE; IDii; AUTH	=>		Key Generated (by responder) Initiator Identity Verified by Responder
(4)		<=	HDR; KE; IDir; AUTH	Responder Identity Verified by Initiator Key Generated (by initiator) SA established

In the first message (1), the initiator generates a proposal it considers adequate to protect traffic for the given situation. The Security Association, Proposal, and Transform payloads are included in the Security Association payload (for notation purposes). Random information which is used to guarantee liveness and protect against replay attacks is also transmitted. Random information provided by both parties SHOULD be used by the authentication mechanism to provide shared proof of participation in the exchange.

In the second message (2), the responder indicates the protection suite it has accepted with the Security Association, Proposal, and Transform payloads. Again, random information which is used to guarantee liveness and protect against replay attacks is also transmitted. Random information provided by both parties SHOULD be used by the authentication mechanism to provide shared proof of participation in the exchange. Local security policy dictates the action of the responder if no proposed protection suite is accepted. One possible action is the transmission of a Notify payload as part of an Informational Exchange.

In the third (3) and fourth (4) messages, the initiator and responder, respectively, exchange keying material used to arrive at a common shared secret and identification information. This information is transmitted under the protection of the agreed upon authentication function. Local security policy dictates the action if an error occurs during these messages. One possible action is the transmission of a Notify payload as part of an Informational Exchange.

4.5 Identity Protection Exchange

The Identity Protection Exchange is designed to separate the Key Exchange information from the Identity and Authentication related information. Separating the Key Exchange from the Identity and Authentication related information provides protection of the communicating identities at the expense of two additional messages. Identities are exchanged under the protection of a previously established common shared secret. The following diagram shows the messages with the possible payloads sent in each message and notes for an example of the Identity Protection Exchange.

IDENTITY PROTECTION EXCHANGE

#	Initiator	Direction	Responder	NOTE
(1)	HDR; SA	=>		Begin ISAKMP-SA or Proxy negotiation
(2)		<=	HDR; SA	Basic SA agreed upon
(3)	HDR; KE; NONCE	=>		Key Generated (by Initiator and Responder)
(4)		<=	HDR; KE; NONCE	
(5)	HDR*; IDii; AUTH	=>		Initiator Identity Verified by Responder
(6)		<=	HDR*; IDir; AUTH	Responder Identity Verified by Initiator SA established

In the first message (1), the initiator generates a proposal it considers adequate to protect traffic for the given situation. The Security Association, Proposal, and Transform payloads are included in the Security Association payload (for notation purposes).

In the second message (2), the responder indicates the protection suite it has accepted with the Security Association, Proposal, and Transform payloads. Local security policy dictates the action of the responder if no proposed protection suite is accepted. One possible action is the transmission of a Notify payload as part of an Informational Exchange.

In the third (3) and fourth (4) messages, the initiator and responder, respectively, exchange keying material used to arrive at a common shared secret and random information which is used to guarantee liveness and protect against replay attacks. Random information provided by both parties SHOULD be used by the authentication mechanism to provide shared proof of participation in the exchange. Local security policy dictates the action if an error occurs during these messages. One possible action is the transmission of a Notify payload as part of an Informational Exchange.

In the fifth (5) and sixth (6) messages, the initiator and responder, respectively, exchange identification information and the results of the agreed upon authentication function. This information is

transmitted under the protection of the common shared secret. Local security policy dictates the action if an error occurs during these messages. One possible action is the transmission of a Notify payload as part of an Informational Exchange.

4.6 Authentication Only Exchange

The Authentication Only Exchange is designed to allow only Authentication related information to be transmitted. The benefit of this exchange is the ability to perform only authentication without the computational expense of computing keys. Using this exchange during negotiation, none of the transmitted information will be encrypted. However, the information may be encrypted in other places. For example, if encryption is negotiated during the first phase of a negotiation and the authentication only exchange is used in the second phase of a negotiation, then the authentication only exchange will be encrypted by the ISAKMP SAs negotiated in the first phase. The following diagram shows the messages with possible payloads sent in each message and notes for an example of the Authentication Only Exchange.

AUTHENTICATION ONLY EXCHANGE

#	Initiator	Direction	Responder	NOTE
(1)	HDR; SA; NONCE	=>		Begin ISAKMP-SA or Proxy negotiation
(2)		<=	HDR; SA; NONCE; IDir; AUTH	Basic SA agreed upon Responder Identity Verified by Initiator
(3)	HDR; IDii; AUTH	=>		Initiator Identity Verified by Responder SA established

In the first message (1), the initiator generates a proposal it considers adequate to protect traffic for the given situation. The Security Association, Proposal, and Transform payloads are included in the Security Association payload (for notation purposes). Random information which is used to guarantee liveness and protect against replay attacks is also transmitted. Random information provided by both parties SHOULD be used by the authentication mechanism to provide shared proof of participation in the exchange.

In the second message (2), the responder indicates the protection suite it has accepted with the Security Association, Proposal, and Transform payloads. Again, random information which is used to

guarantee liveness and protect against replay attacks is also transmitted. Random information provided by both parties SHOULD be used by the authentication mechanism to provide shared proof of participation in the exchange. Additionally, the responder transmits identification information. All of this information is transmitted under the protection of the agreed upon authentication function. Local security policy dictates the action of the responder if no proposed protection suite is accepted. One possible action is the transmission of a Notify payload as part of an Informational Exchange.

In the third message (3), the initiator transmits identification information. This information is transmitted under the protection of the agreed upon authentication function. Local security policy dictates the action if an error occurs during these messages. One possible action is the transmission of a Notify payload as part of an Informational Exchange.

4.7 Aggressive Exchange

The Aggressive Exchange is designed to allow the Security Association, Key Exchange and Authentication related payloads to be transmitted together. Combining the Security Association, Key Exchange, and Authentication-related information into one message reduces the number of round-trips at the expense of not providing identity protection. Identity protection is not provided because identities are exchanged before a common shared secret has been established and, therefore, encryption of the identities is not possible. Additionally, the Aggressive Exchange is attempting to establish all security relevant information in a single exchange. The following diagram shows the messages with possible payloads sent in each message and notes for an example of the Aggressive Exchange.

AGGRESSIVE EXCHANGE

#	Initiator	Direction	Responder	NOTE
(1)	HDR; SA; KE; NONCE; IDii	=>		Begin ISAKMP-SA or Proxy negotiation and Key Exchange
(2)		<=	HDR; SA; KE; NONCE; IDir; AUTH	Initiator Identity Verified by Responder Key Generated Basic SA agreed upon
(3)	HDR*; AUTH	=>		Responder Identity Verified by Initiator SA established

In the first message (1), the initiator generates a proposal it considers adequate to protect traffic for the given situation. The Security Association, Proposal, and Transform payloads are included in the Security Association payload (for notation purposes). There can be only one Proposal and one Transform offered (i.e. no choices) in order for the aggressive exchange to work. Keying material used to arrive at a common shared secret and random information which is used to guarantee liveness and protect against replay attacks are also transmitted. Random information provided by both parties SHOULD be used by the authentication mechanism to provide shared proof of participation in the exchange. Additionally, the initiator transmits identification information.

In the second message (2), the responder indicates the protection suite it has accepted with the Security Association, Proposal, and Transform payloads. Keying material used to arrive at a common shared secret and random information which is used to guarantee liveness and protect against replay attacks is also transmitted. Random information provided by both parties SHOULD be used by the authentication mechanism to provide shared proof of participation in the exchange. Additionally, the responder transmits identification information. All of this information is transmitted under the protection of the agreed upon authentication function. Local security policy dictates the action of the responder if no proposed protection suite is accepted. One possible action is the transmission of a Notify payload as part of an Informational Exchange.

In the third (3) message, the initiator transmits the results of the agreed upon authentication function. This information is transmitted under the protection of the common shared secret. Local security policy dictates the action if an error occurs during these messages. One possible action is the transmission of a Notify payload as part of an Informational Exchange.

4.8 Informational Exchange

The Informational Exchange is designed as a one-way transmittal of information that can be used for security association management. The following diagram shows the messages with possible payloads sent in each message and notes for an example of the Informational Exchange.

INFORMATIONAL EXCHANGE

#	Initiator	Direction	Responder	NOTE
(1)	HDR*; N/D	=>		Error Notification or Deletion

In the first message (1), the initiator or responder transmits an ISAKMP Notify or Delete payload.

If the Informational Exchange occurs prior to the exchange of keying material during an ISAKMP Phase 1 negotiation, there will be no protection provided for the Informational Exchange. Once keying material has been exchanged or an ISAKMP SA has been established, the Informational Exchange MUST be transmitted under the protection provided by the keying material or the ISAKMP SA.

All exchanges are similar in that with the beginning of any exchange, cryptographic synchronization MUST occur. The Informational Exchange is an exchange and not an ISAKMP message. Thus, the generation of an Message ID (MID) for an Informational Exchange SHOULD be independent of IVs of other on-going communication. This will ensure cryptographic synchronization is maintained for existing communications and the Informational Exchange will be processed correctly. The only exception to this is when the Commit Bit of the ISAKMP Header is set. When the Commit Bit is set, the Message ID field of the Informational Exchange MUST contain the Message ID of the original ISAKMP Phase 2 SA negotiation, rather than a new Message ID (MID). This is done to ensure that the Informational Exchange with the CONNECTED Notify Message can be associated with the correct Phase 2 SA. For a description of the Commit Bit, see section 3.1.

5 ISAKMP Payload Processing

Section 3 describes the ISAKMP payloads. These payloads are used in the exchanges described in section 4 and can be used in exchanges defined for a specific DOI. This section describes the processing for each of the payloads. This section suggests the logging of events to a system audit file. This action is controlled by a system security policy and is, therefore, only a suggested action.

5.1 General Message Processing

Every ISAKMP message has basic processing applied to insure protocol reliability, and to minimize threats, such as denial of service and replay attacks. All processing SHOULD include packet length checks to insure the packet received is at least as long as the length given in the ISAKMP Header. If the ISAKMP message length and the value in the Payload Length field of the ISAKMP Header are not the same, then the ISAKMP message MUST be rejected. The receiving entity (initiator or responder) MUST do the following:

1. The event, UNEQUAL PAYLOAD LENGTHS, MAY be logged in the appropriate system audit file.
2. An Informational Exchange with a Notification payload containing the UNEQUAL-PAYLOAD-LENGTHS message type MAY be sent to the transmitting entity. This action is dictated by a system security policy.

When transmitting an ISAKMP message, the transmitting entity (initiator or responder) MUST do the following:

1. Set a timer and initialize a retry counter.

NOTE: Implementations MUST NOT use a fixed timer. Instead, transmission timer values should be adjusted dynamically based on measured round trip times. In addition, successive retransmissions of the same packet should be separated by increasingly longer time intervals (e.g., exponential backoff).

2. If the timer expires, the ISAKMP message is resent and the retry counter is decremented.
3. If the retry counter reaches zero (0), the event, RETRY LIMIT REACHED, MAY be logged in the appropriate system audit file.
4. The ISAKMP protocol machine clears all states and returns to IDLE.

5.2 ISAKMP Header Processing

When creating an ISAKMP message, the transmitting entity (initiator or responder) MUST do the following:

1. Create the respective cookie. See section 2.5.3 for details.
2. Determine the relevant security characteristics of the session (i.e. DOI and situation).
3. Construct an ISAKMP Header with fields as described in section 3.1.
4. Construct other ISAKMP payloads, depending on the exchange type.
5. Transmit the message to the destination host as described in section 5.1.

When an ISAKMP message is received, the receiving entity (initiator or responder) MUST do the following:

1. Verify the Initiator and Responder "cookies". If the cookie validation fails, the message is discarded and the following actions are taken:
 - (a) The event, INVALID COOKIE, MAY be logged in the appropriate system audit file.
 - (b) An Informational Exchange with a Notification payload containing the INVALID-COOKIE message type MAY be sent to the transmitting entity. This action is dictated by a system security policy.
2. Check the Next Payload field to confirm it is valid. If the Next Payload field validation fails, the message is discarded and the following actions are taken:
 - (a) The event, INVALID NEXT PAYLOAD, MAY be logged in the appropriate system audit file.
 - (b) An Informational Exchange with a Notification payload containing the INVALID-PAYLOAD-TYPE message type MAY be sent to the transmitting entity. This action is dictated by a system security policy.
3. Check the Major and Minor Version fields to confirm they are correct (see section 3.1). If the Version field validation fails, the message is discarded and the following actions are

taken:

- (a) The event, INVALID ISAKMP VERSION, MAY be logged in the appropriate system audit file.
 - (b) An Informational Exchange with a Notification payload containing the INVALID-MAJOR-VERSION or INVALID-MINOR-VERSION message type MAY be sent to the transmitting entity. This action is dictated by a system security policy.
4. Check the Exchange Type field to confirm it is valid. If the Exchange Type field validation fails, the message is discarded and the following actions are taken:
 - (a) The event, INVALID EXCHANGE TYPE, MAY be logged in the appropriate system audit file.
 - (b) An Informational Exchange with a Notification payload containing the INVALID-EXCHANGE-TYPE message type MAY be sent to the transmitting entity. This action is dictated by a system security policy.
5. Check the Flags field to ensure it contains correct values. If the Flags field validation fails, the message is discarded and the following actions are taken:
 - (a) The event, INVALID FLAGS, MAY be logged in the appropriate systemaudit file.
 - (b) An Informational Exchange with a Notification payload containing the INVALID-FLAGS message type MAY be sent to the transmitting entity. This action is dictated by a system security policy.
6. Check the Message ID field to ensure it contains correct values. If the Message ID validation fails, the message is discarded and the following actions are taken:
 - (a) The event, INVALID MESSAGE ID, MAY be logged in the appropriate system audit file.
 - (b) An Informational Exchange with a Notification payload containing the INVALID-MESSAGE-ID message type MAY be sent to the transmitting entity. This action is dictated by a system security policy.
7. Processing of the ISAKMP message continues using the value in the Next Payload field.

5.3 Generic Payload Header Processing

When creating any of the ISAKMP Payloads described in sections 3.4 through 3.15 a Generic Payload Header is placed at the beginning of these payloads. When creating the Generic Payload Header, the transmitting entity (initiator or responder) MUST do the following:

1. Place the value of the Next Payload in the Next Payload field. These values are described in section 3.1.
2. Place the value zero (0) in the RESERVED field.
3. Place the length (in octets) of the payload in the Payload Length field.
4. Construct the payloads as defined in the remainder of this section.

When any of the ISAKMP Payloads are received, the receiving entity (initiator or responder) MUST do the following:

1. Check the Next Payload field to confirm it is valid. If the Next Payload field validation fails, the message is discarded and the following actions are taken:
 - (a) The event, INVALID NEXT PAYLOAD, MAY be logged in the appropriate system audit file.
 - (b) An Informational Exchange with a Notification payload containing the INVALID-PAYLOAD-TYPE message type MAY be sent to the transmitting entity. This action is dictated by a system security policy.
2. Verify the RESERVED field contains the value zero. If the value in the RESERVED field is not zero, the message is discarded and the following actions are taken:
 - (a) The event, INVALID RESERVED FIELD, MAY be logged in the appropriate system audit file.
 - (b) An Informational Exchange with a Notification payload containing the BAD-PROPOSAL-SYNTAX or PAYLOAD-MALFORMED message type MAY be sent to the transmitting entity. This action is dictated by a system security policy.
3. Process the remaining payloads as defined by the Next Payload field.

5.4 Security Association Payload Processing

When creating a Security Association Payload, the transmitting entity (initiator or responder) MUST do the following:

1. Determine the Domain of Interpretation for which this negotiation is being performed.
2. Determine the situation within the determined DOI for which this negotiation is being performed.
3. Determine the proposal(s) and transform(s) within the situation. These are described, respectively, in sections 3.5 and 3.6.
4. Construct a Security Association payload.
5. Transmit the message to the receiving entity as described in section 5.1.

When a Security Association payload is received, the receiving entity (initiator or responder) MUST do the following:

1. Determine if the Domain of Interpretation (DOI) is supported. If the DOI determination fails, the message is discarded and the following actions are taken:
 - (a) The event, INVALID DOI, MAY be logged in the appropriate system audit file.
 - (b) An Informational Exchange with a Notification payload containing the DOI-NOT-SUPPORTED message type MAY be sent to the transmitting entity. This action is dictated by a system security policy.
2. Determine if the given situation can be protected. If the Situation determination fails, the message is discarded and the following actions are taken:
 - (a) The event, INVALID SITUATION, MAY be logged in the appropriate system audit file.
 - (b) An Informational Exchange with a Notification payload containing the SITUATION-NOT-SUPPORTED message type MAY be sent to the transmitting entity. This action is dictated by a system security policy.
3. Process the remaining payloads (i.e. Proposal, Transform) of the Security Association Payload. If the Security Association

Proposal (as described in sections 5.5 and 5.6) is not accepted, then the following actions are taken:

- (a) The event, INVALID PROPOSAL, MAY be logged in the appropriate system audit file.
- (b) An Informational Exchange with a Notification payload containing the NO-PROPOSAL-CHOSEN message type MAY be sent to the transmitting entity. This action is dictated by a system security policy.

5.5 Proposal Payload Processing

When creating a Proposal Payload, the transmitting entity (initiator or responder) MUST do the following:

1. Determine the Protocol for this proposal.
2. Determine the number of proposals to be offered for this protocol and the number of transforms for each proposal. Transforms are described in section 3.6.
3. Generate a unique pseudo-random SPI.
4. Construct a Proposal payload.

When a Proposal payload is received, the receiving entity (initiator or responder) MUST do the following:

1. Determine if the Protocol is supported. If the Protocol-ID field is invalid, the payload is discarded and the following actions are taken:
 - (a) The event, INVALID PROTOCOL, MAY be logged in the appropriate system audit file.
 - (b) An Informational Exchange with a Notification payload containing the INVALID-PROTOCOL-ID message type MAY be sent to the transmitting entity. This action is dictated by a system security policy.
2. Determine if the SPI is valid. If the SPI is invalid, the payload is discarded and the following actions are taken:
 - (a) The event, INVALID SPI, MAY be logged in the appropriate system audit file.

- (b) An Informational Exchange with a Notification payload containing the INVALID-SPI message type MAY be sent to the transmitting entity. This action is dictated by a system security policy.
3. Ensure the Proposals are presented according to the details given in section 3.5 and 4.2. If the proposals are not formed correctly, the following actions are taken:
 - (a) Possible events, BAD PROPOSAL SYNTAX, INVALID PROPOSAL, are logged in the appropriate system audit file.
 - (b) An Informational Exchange with a Notification payload containing the BAD-PROPOSAL-SYNTAX or PAYLOAD-MALFORMED message type MAY be sent to the transmitting entity. This action is dictated by a system security policy.
 4. Process the Proposal and Transform payloads as defined by the Next Payload field. Examples of processing these payloads are given in section 4.2.1.

5.6 Transform Payload Processing

When creating a Transform Payload, the transmitting entity (initiator or responder) MUST do the following:

1. Determine the Transform # for this transform.
2. Determine the number of transforms to be offered for this proposal. Transforms are described in sections 3.6.
3. Construct a Transform payload.

When a Transform payload is received, the receiving entity (initiator or responder) MUST do the following:

1. Determine if the Transform is supported. If the Transform-ID field contains an unknown or unsupported value, then that Transform payload MUST be ignored and MUST NOT cause the generation of an INVALID TRANSFORM event. If the Transform-ID field is invalid, the payload is discarded and the following actions are taken:
 - (a) The event, INVALID TRANSFORM, MAY be logged in the appropriate system audit file.
 - (b) An Informational Exchange with a Notification payload containing the INVALID-TRANSFORM-ID message type MAY be sent

to the transmitting entity. This action is dictated by a system security policy.

2. Ensure the Transforms are presented according to the details given in section 3.6 and 4.2. If the transforms are not formed correctly, the following actions are taken:
 - (a) Possible events, BAD PROPOSAL SYNTAX, INVALID TRANSFORM, INVALID ATTRIBUTES, are logged in the appropriate system audit file.
 - (b) An Informational Exchange with a Notification payload containing the BAD-PROPOSAL-SYNTAX, PAYLOAD-MALFORMED or ATTRIBUTES-NOT-SUPPORTED message type MAY be sent to the transmitting entity. This action is dictated by a system security policy.
3. Process the subsequent Transform and Proposal payloads as defined by the Next Payload field. Examples of processing these payloads are given in section 4.2.1.

5.7 Key Exchange Payload Processing

When creating a Key Exchange Payload, the transmitting entity (initiator or responder) MUST do the following:

1. Determine the Key Exchange to be used as defined by the DOI.
2. Determine the usage of the Key Exchange Data field as defined by the DOI.
3. Construct a Key Exchange payload.
4. Transmit the message to the receiving entity as described in section 5.1.

When a Key Exchange payload is received, the receiving entity (initiator or responder) MUST do the following:

1. Determine if the Key Exchange is supported. If the Key Exchange determination fails, the message is discarded and the following actions are taken:
 - (a) The event, INVALID KEY INFORMATION, MAY be logged in the appropriate system audit file.
 - (b) An Informational Exchange with a Notification payload containing the INVALID-KEY-INFORMATION message type MAY be

sent to the transmitting entity. This action is dictated by a system security policy.

5.8 Identification Payload Processing

When creating an Identification Payload, the transmitting entity (initiator or responder) MUST do the following:

1. Determine the Identification information to be used as defined by the DOI (and possibly the situation).
2. Determine the usage of the Identification Data field as defined by the DOI.
3. Construct an Identification payload.
4. Transmit the message to the receiving entity as described in section 5.1.

When an Identification payload is received, the receiving entity (initiator or responder) MUST do the following:

1. Determine if the Identification Type is supported. This may be based on the DOI and Situation. If the Identification determination fails, the message is discarded and the following actions are taken:
 - (a) The event, INVALID ID INFORMATION, MAY be logged in the appropriate system audit file.
 - (b) An Informational Exchange with a Notification payload containing the INVALID-ID-INFORMATION message type MAY be sent to the transmitting entity. This action is dictated by a system security policy.

5.9 Certificate Payload Processing

When creating a Certificate Payload, the transmitting entity (initiator or responder) MUST do the following:

1. Determine the Certificate Encoding to be used. This may be specified by the DOI.
2. Ensure the existence of a certificate formatted as defined by the Certificate Encoding.
3. Construct a Certificate payload.

4. Transmit the message to the receiving entity as described in section 5.1.

When a Certificate payload is received, the receiving entity (initiator or responder) MUST do the following:

1. Determine if the Certificate Encoding is supported. If the Certificate Encoding is not supported, the payload is discarded and the following actions are taken:
 - (a) The event, INVALID CERTIFICATE TYPE, MAY be logged in the appropriate system audit file.
 - (b) An Informational Exchange with a Notification payload containing the INVALID-CERT-ENCODING message type MAY be sent to the transmitting entity. This action is dictated by a system security policy.
2. Process the Certificate Data field. If the Certificate Data is invalid or improperly formatted, the payload is discarded and the following actions are taken:
 - (a) The event, INVALID CERTIFICATE, MAY be logged in the appropriate system audit file.
 - (b) An Informational Exchange with a Notification payload containing the INVALID-CERTIFICATE message type MAY be sent to the transmitting entity. This action is dictated by a system security policy.

5.10 Certificate Request Payload Processing

When creating a Certificate Request Payload, the transmitting entity (initiator or responder) MUST do the following:

1. Determine the type of Certificate Encoding to be requested. This may be specified by the DOI.
2. Determine the name of an acceptable Certificate Authority which is to be requested (if applicable).
3. Construct a Certificate Request payload.
4. Transmit the message to the receiving entity as described in section 5.1.

When a Certificate Request payload is received, the receiving entity (initiator or responder) MUST do the following:

1. Determine if the Certificate Encoding is supported. If the Certificate Encoding is invalid, the payload is discarded and the following actions are taken:
 - (a) The event, INVALID CERTIFICATE TYPE, MAY be logged in the appropriate system audit file.
 - (b) An Informational Exchange with a Notification payload containing the INVALID-CERT-ENCODING message type MAY be sent to the transmitting entity. This action is dictated by a system security policy.

If the Certificate Encoding is not supported, the payload is discarded and the following actions are taken:

- (a) The event, CERTIFICATE TYPE UNSUPPORTED, MAY be logged in the appropriate system audit file.
 - (b) An Informational Exchange with a Notification payload containing the CERT-TYPE-UNSUPPORTED message type MAY be sent to the transmitting entity. This action is dictated by a system security policy.
2. Determine if the Certificate Authority is supported for the specified Certificate Encoding. If the Certificate Authority is invalid or improperly formatted, the payload is discarded and the following actions are taken:
 - (a) The event, INVALID CERTIFICATE AUTHORITY, MAY be logged in the appropriate system audit file.
 - (b) An Informational Exchange with a Notification payload containing the INVALID-CERT-AUTHORITY message type MAY be sent to the transmitting entity. This action is dictated by a system security policy.
 3. Process the Certificate Request. If a requested Certificate Type with the specified Certificate Authority is not available, then the payload is discarded and the following actions are taken:
 - (a) The event, CERTIFICATE-UNAVAILABLE, MAY be logged in the appropriate system audit file.
 - (b) An Informational Exchange with a Notification payload containing the CERTIFICATE-UNAVAILABLE message type MAY be sent to the transmitting entity. This action is dictated by a system security policy.

5.11 Hash Payload Processing

When creating a Hash Payload, the transmitting entity (initiator or responder) MUST do the following:

1. Determine the Hash function to be used as defined by the SA negotiation.
2. Determine the usage of the Hash Data field as defined by the DOI.
3. Construct a Hash payload.
4. Transmit the message to the receiving entity as described in section 5.1.

When a Hash payload is received, the receiving entity (initiator or responder) MUST do the following:

1. Determine if the Hash is supported. If the Hash determination fails, the message is discarded and the following actions are taken:
 - (a) The event, INVALID HASH INFORMATION, MAY be logged in the appropriate system audit file.
 - (b) An Informational Exchange with a Notification payload containing the INVALID-HASH-INFORMATION message type MAY be sent to the transmitting entity. This action is dictated by a system security policy.
2. Perform the Hash function as outlined in the DOI and/or Key Exchange protocol documents. If the Hash function fails, the message is discarded and the following actions are taken:
 - (a) The event, INVALID HASH VALUE, MAY be logged in the appropriate system audit file.
 - (b) An Informational Exchange with a Notification payload containing the AUTHENTICATION-FAILED message type MAY be sent to the transmitting entity. This action is dictated by a system security policy.

5.12 Signature Payload Processing

When creating a Signature Payload, the transmitting entity (initiator or responder) MUST do the following:

1. Determine the Signature function to be used as defined by the SA negotiation.
2. Determine the usage of the Signature Data field as defined by the DOI.
3. Construct a Signature payload.
4. Transmit the message to the receiving entity as described in section 5.1.

When a Signature payload is received, the receiving entity (initiator or responder) MUST do the following:

1. Determine if the Signature is supported. If the Signature determination fails, the message is discarded and the following actions are taken:
 - (a) The event, INVALID SIGNATURE INFORMATION, MAY be logged in the appropriate system audit file.
 - (b) An Informational Exchange with a Notification payload containing the INVALID-SIGNATURE message type MAY be sent to the transmitting entity. This action is dictated by a system security policy.
2. Perform the Signature function as outlined in the DOI and/or Key Exchange protocol documents. If the Signature function fails, the message is discarded and the following actions are taken:
 - (a) The event, INVALID SIGNATURE VALUE, MAY be logged in the appropriate system audit file.
 - (b) An Informational Exchange with a Notification payload containing the AUTHENTICATION-FAILED message type MAY be sent to the transmitting entity. This action is dictated by a system security policy.

5.13 Nonce Payload Processing

When creating a Nonce Payload, the transmitting entity (initiator or responder) MUST do the following:

1. Create a unique random value to be used as a nonce.
2. Construct a Nonce payload.

3. Transmit the message to the receiving entity as described in section 5.1.

When a Nonce payload is received, the receiving entity (initiator or responder) MUST do the following:

1. There are no specific procedures for handling Nonce payloads. The procedures are defined by the exchange types (and possibly the DOI and Key Exchange descriptions).

5.14 Notification Payload Processing

During communications it is possible that errors may occur. The Informational Exchange with a Notify Payload provides a controlled method of informing a peer entity that errors have occurred during protocol processing. It is RECOMMENDED that Notify Payloads be sent in a separate Informational Exchange rather than appending a Notify Payload to an existing exchange.

When creating a Notification Payload, the transmitting entity (initiator or responder) MUST do the following:

1. Determine the DOI for this Notification.
2. Determine the Protocol-ID for this Notification.
3. Determine the SPI size based on the Protocol-ID field. This field is necessary because different security protocols have different SPI sizes. For example, ISAKMP combines the Initiator and Responder cookie pair (16 octets) as a SPI, while ESP and AH have 4 octet SPIs.
4. Determine the Notify Message Type based on the error or status message desired.
5. Determine the SPI which is associated with this notification.
6. Determine if additional Notification Data is to be included. This is additional information specified by the DOI.
7. Construct a Notification payload.
8. Transmit the message to the receiving entity as described in section 5.1.

Because the Informational Exchange with a Notification payload is a unidirectional message a retransmission will not be performed. The local security policy will dictate the procedures for continuing.

However, we RECOMMEND that a NOTIFICATION PAYLOAD ERROR event be logged in the appropriate system audit file by the receiving entity.

If the Informational Exchange occurs prior to the exchange of keying material during an ISAKMP Phase 1 negotiation there will be no protection provided for the Informational Exchange. Once the keying material has been exchanged or the ISAKMP SA has been established, the Informational Exchange MUST be transmitted under the protection provided by the keying material or the ISAKMP SA.

When a Notification payload is received, the receiving entity (initiator or responder) MUST do the following:

1. Determine if the Informational Exchange has any protection applied to it by checking the Encryption Bit and the Authentication Only Bit in the ISAKMP Header. If the Encryption Bit is set, i.e. the Informational Exchange is encrypted, then the message MUST be decrypted using the (in-progress or completed) ISAKMP SA. Once the decryption is complete the processing can continue as described below. If the Authentication Only Bit is set, then the message MUST be authenticated using the (in-progress or completed) ISAKMP SA. Once the authentication is completed, the processing can continue as described below. If the Informational Exchange is not encrypted or authentication, the payload processing can continue as described below.
2. Determine if the Domain of Interpretation (DOI) is supported. If the DOI determination fails, the payload is discarded and the following action is taken:
 - (a) The event, INVALID DOI, MAY be logged in the appropriate system audit file.
3. Determine if the Protocol-Id is supported. If the Protocol-Id determination fails, the payload is discarded and the following action is taken:
 - (a) The event, INVALID PROTOCOL-ID, MAY be logged in the appropriate system audit file.
4. Determine if the SPI is valid. If the SPI is invalid, the payload is discarded and the following action is taken:
 - (a) The event, INVALID SPI, MAY be logged in the appropriate system audit file.

5. Determine if the Notify Message Type is valid. If the Notify Message Type is invalid, the payload is discarded and the following action is taken:
 - (a) The event, INVALID MESSAGE TYPE, MAY be logged in the appropriate system audit file.
6. Process the Notification payload, including additional Notification Data, and take appropriate action, according to local security policy.

5.15 Delete Payload Processing

During communications it is possible that hosts may be compromised or that information may be intercepted during transmission. Determining whether this has occurred is not an easy task and is outside the scope of this memo. However, if it is discovered that transmissions are being compromised, then it is necessary to establish a new SA and delete the current SA.

The Informational Exchange with a Delete Payload provides a controlled method of informing a peer entity that the transmitting entity has deleted the SA(s). Deletion of Security Associations MUST always be performed under the protection of an ISAKMP SA. The receiving entity SHOULD clean up its local SA database. However, upon receipt of a Delete message the SAs listed in the Security Parameter Index (SPI) field of the Delete payload cannot be used with the transmitting entity. The SA Establishment procedure must be invoked to re-establish secure communications.

When creating a Delete Payload, the transmitting entity (initiator or responder) MUST do the following:

1. Determine the DOI for this Deletion.
2. Determine the Protocol-ID for this Deletion.
3. Determine the SPI size based on the Protocol-ID field. This field is necessary because different security protocols have different SPI sizes. For example, ISAKMP combines the Initiator and Responder cookie pair (16 octets) as a SPI, while ESP and AH have 4 octet SPIs.
4. Determine the # of SPIs to be deleted for this protocol.
5. Determine the SPI(s) which is (are) associated with this deletion.

6. Construct a Delete payload.
7. Transmit the message to the receiving entity as described in section 5.1.

Because the Informational Exchange with a Delete payload is a unidirectional message a retransmission will not be performed. The local security policy will dictate the procedures for continuing. However, we RECOMMEND that a DELETE PAYLOAD ERROR event be logged in the appropriate system audit file by the receiving entity.

As described above, the Informational Exchange with a Delete payload MUST be transmitted under the protection provided by an ISAKMP SA.

When a Delete payload is received, the receiving entity (initiator or responder) MUST do the following:

1. Because the Informational Exchange is protected by some security service (e.g. authentication for an Auth-Only SA, encryption for other exchanges), the message MUST have these security services applied using the ISAKMP SA. Once the security service processing is complete the processing can continue as described below. Any errors that occur during the security service processing will be evident when checking information in the Delete payload. The local security policy SHOULD dictate any action to be taken as a result of security service processing errors.
2. Determine if the Domain of Interpretation (DOI) is supported. If the DOI determination fails, the payload is discarded and the following action is taken:
 - (a) The event, INVALID DOI, MAY be logged in the appropriate system audit file.
3. Determine if the Protocol-Id is supported. If the Protocol-Id determination fails, the payload is discarded and the following action is taken:
 - (a) The event, INVALID PROTOCOL-ID, MAY be logged in the appropriate system audit file.
4. Determine if the SPI is valid for each SPI included in the Delete payload. For each SPI that is invalid, the following action is taken:
 - (a) The event, INVALID SPI, MAY be logged in the appropriate system audit file.

5. Process the Delete payload and take appropriate action, according to local security policy. As described above, one appropriate action SHOULD include cleaning up the local SA database.

6 Conclusions

The Internet Security Association and Key Management Protocol (ISAKMP) is a well designed protocol aimed at the Internet of the future. The massive growth of the Internet will lead to great diversity in network utilization, communications, security requirements, and security mechanisms. ISAKMP contains all the features that will be needed for this dynamic and expanding communications environment.

ISAKMP's Security Association (SA) feature coupled with authentication and key establishment provides the security and flexibility that will be needed for future growth and diversity. This security diversity of multiple key exchange techniques, encryption algorithms, authentication mechanisms, security services, and security attributes will allow users to select the appropriate security for their network, communications, and security needs. The SA feature allows users to specify and negotiate security requirements with other users. An additional benefit of supporting multiple techniques in a single protocol is that as new techniques are developed they can easily be added to the protocol. This provides a path for the growth of Internet security services. ISAKMP supports both publicly or privately defined SAs, making it ideal for government, commercial, and private communications.

ISAKMP provides the ability to establish SAs for multiple security protocols and applications. These protocols and applications may be session-oriented or sessionless. Having one SA establishment protocol that supports multiple security protocols eliminates the need for multiple, nearly identical authentication, key exchange and SA establishment protocols when more than one security protocol is in use or desired. Just as IP has provided the common networking layer for the Internet, a common security establishment protocol is needed if security is to become a reality on the Internet. ISAKMP provides the common base that allows all other security protocols to interoperate.

ISAKMP follows good security design principles. It is not coupled to other insecure transport protocols, therefore it is not vulnerable or weakened by attacks on other protocols. Also, when more secure transport protocols are developed, ISAKMP can be easily migrated to them. ISAKMP also provides protection against protocol related attacks. This protection provides the assurance that the SAs and keys established are with the desired party and not with an attacker.

ISAKMP also follows good protocol design principles. Protocol specific information only is in the protocol header, following the design principles of IPv6. The data transported by the protocol is separated into functional payloads. As the Internet grows and evolves, new payloads to support new security functionality can be added without modifying the entire protocol.

A ISAKMP Security Association Attributes

A.1 Background/Rationale

As detailed in previous sections, ISAKMP is designed to provide a flexible and extensible framework for establishing and managing Security Associations and cryptographic keys. The framework provided by ISAKMP consists of header and payload definitions, exchange types for guiding message and payload exchanges, and general processing guidelines. ISAKMP does not define the mechanisms that will be used to establish and manage Security Associations and cryptographic keys in an authenticated and confidential manner. The definition of mechanisms and their application is the purview of individual Domains of Interpretation (DOIs).

This section describes the ISAKMP values for the Internet IP Security DOI, supported security protocols, and identification values for ISAKMP Phase 1 negotiations. The Internet IP Security DOI is MANDATORY to implement for IP Security. [Oakley] and [IKE] describe, in detail, the mechanisms and their application for establishing and managing Security Associations and cryptographic keys for IP Security.

A.2 Internet IP Security DOI Assigned Value

As described in [IPDOI], the Internet IP Security DOI Assigned Number is one (1).

A.3 Supported Security Protocols

Values for supported security protocols are specified in the most recent "Assigned Numbers" RFC [STD-2]. Presented in the following table are the values for the security protocols supported by ISAKMP for the Internet IP Security DOI.

Protocol Assigned Value	
RESERVED	0
ISAKMP	1

All DOIs MUST reserve ISAKMP with a Protocol-ID of 1. All other security protocols within that DOI will be numbered accordingly.

Security protocol values 2-15359 are reserved to IANA for future use. Values 15360-16383 are permanently reserved for private use amongst mutually consenting implementations. Such private use values are unlikely to be interoperable across different implementations.

A.4 ISAKMP Identification Type Values

The following table lists the assigned values for the Identification Type field found in the Identification payload during a generic Phase 1 exchange, which is not for a specific protocol.

ID Type	Value
ID_IPV4_ADDR	0
ID_IPV4_ADDR_SUBNET	1
ID_IPV6_ADDR	2
ID_IPV6_ADDR_SUBNET	3

A.4.1 ID_IPV4_ADDR

The ID_IPV4_ADDR type specifies a single four (4) octet IPv4 address.

A.4.2 ID_IPV4_ADDR_SUBNET

The ID_IPV4_ADDR_SUBNET type specifies a range of IPv4 addresses, represented by two four (4) octet values. The first value is an IPv4 address. The second is an IPv4 network mask. Note that ones (1s) in the network mask indicate that the corresponding bit in the address is fixed, while zeros (0s) indicate a "wildcard" bit.

A.4.3 ID_IPV6_ADDR

The ID_IPV6_ADDR type specifies a single sixteen (16) octet IPv6 address.

A.4.4 ID_IPV6_ADDR_SUBNET

The ID_IPV6_ADDR_SUBNET type specifies a range of IPv6 addresses, represented by two sixteen (16) octet values. The first value is an IPv6 address. The second is an IPv6 network mask. Note that ones (1s) in the network mask indicate that the corresponding bit in the address is fixed, while zeros (0s) indicate a "wildcard" bit.

B Defining a new Domain of Interpretation

The Internet DOI may be sufficient to meet the security requirements of a large portion of the internet community. However, some groups may have a need to customize some aspect of a DOI, perhaps to add a different set of cryptographic algorithms, or perhaps because they want to make their security-relevant decisions based on something other than a host id or user id. Also, a particular group may have a need for a new exchange type, for example to support key management for multicast groups.

This section discusses guidelines for defining a new DOI. The full specification for the Internet DOI can be found in [IPDOI].

Defining a new DOI is likely to be a time-consuming process. If at all possible, it is recommended that the designer begin with an existing DOI and customize only the parts that are unacceptable.

If a designer chooses to start from scratch, the following MUST be defined:

- o A "situation": the set of information that will be used to determine the required security services.
- o The set of security policies that must be supported.
- o A scheme for naming security-relevant information, including encryption algorithms, key exchange algorithms, etc.
- o A syntax for the specification of proposed security services, attributes, and certificate authorities.
- o The specific formats of the various payload contents.
- o Additional exchange types, if required.

B.1 Situation

The situation is the basis for deciding how to protect a communications channel. It must contain all of the data that will be used to determine the types and strengths of protections applied in an SA. For example, a US Department of Defense DOI would probably use unpublished algorithms and have additional special attributes to negotiate. These additional security attributes would be included in the situation.

B.2 Security Policies

Security policies define how various types of information must be categorized and protected. The DOI must define the set of security policies supported, because both parties in a negotiation must trust that the other party understands a situation, and will protect information appropriately, both in transit and in storage. In a corporate setting, for example, both parties in a negotiation must agree to the meaning of the term "proprietary information" before they can negotiate how to protect it.

Note that including the required security policies in the DOI only specifies that the participating hosts understand and implement those policies in a full system context.

B.3 Naming Schemes

Any DOI must define a consistent way to name cryptographic algorithms, certificate authorities, etc. This can usually be done by using IANA naming conventions, perhaps with some private extensions.

B.4 Syntax for Specifying Security Services

In addition to simply specifying how to name entities, the DOI must also specify the format for complete proposals of how to protect traffic under a given situation.

B.5 Payload Specification

The DOI must specify the format of each of the payload types. For several of the payload types, ISAKMP has included fields that would have to be present across all DOI (such as a certificate authority in the certificate payload, or a key exchange identifier in the key exchange payload).

B.6 Defining new Exchange Types

If the basic exchange types are inadequate to meet the requirements within a DOI, a designer can define up to thirteen extra exchange types per DOI. The designer creates a new exchange type by choosing an unused exchange type value, and defining a sequence of messages composed of strings of the ISAKMP payload types.

Note that any new exchange types must be rigorously analyzed for vulnerabilities. Since this is an expensive and imprecise undertaking, a new exchange type should only be created when absolutely necessary.

Security Considerations

Cryptographic analysis techniques are improving at a steady pace. The continuing improvement in processing power makes once computationally prohibitive cryptographic attacks more realistic. New cryptographic algorithms and public key generation techniques are also being developed at a steady pace. New security services and mechanisms are being developed at an accelerated pace. A consistent method of choosing from a variety of security services and mechanisms and to exchange attributes required by the mechanisms is important to security in the complex structure of the Internet. However, a system that locks itself into a single cryptographic algorithm, key exchange technique, or security mechanism will become increasingly vulnerable as time passes.

UDP is an unreliable datagram protocol and therefore its use in ISAKMP introduces a number of security considerations. Since UDP is unreliable, but a key management protocol must be reliable, the reliability is built into ISAKMP. While ISAKMP utilizes UDP as its transport mechanism, it doesn't rely on any UDP information (e.g. checksum, length) for its processing.

Another issue that must be considered in the development of ISAKMP is the effect of firewalls on the protocol. Many firewalls filter out all UDP packets, making reliance on UDP questionable in certain environments.

A number of very important security considerations are presented in [SEC-ARCH]. One bears repeating. Once a private session key is created, it must be safely stored. Failure to properly protect the private key from access both internal and external to the system completely nullifies any protection provided by the IP Security services.

IANA Considerations

This document contains many "magic" numbers to be maintained by the IANA. This section explains the criteria to be used by the IANA to assign additional numbers in each of these lists.

Domain of Interpretation

The Domain of Interpretation (DOI) is a 32-bit field which identifies the domain under which the security association negotiation is taking place. Requests for assignments of new DOIs must be accompanied by a standards-track RFC which describes the specific domain.

Supported Security Protocols

ISAKMP is designed to provide security association negotiation and key management for many security protocols. Requests for identifiers for additional security protocols must be accompanied by a standards-track RFC which describes the security protocol and its relationship to ISAKMP.

Acknowledgements

Dan Harkins, Dave Carrel, and Derrell Piper of Cisco Systems provided design assistance with the protocol and coordination for the [IKE] and [IPDOI] documents.

Hilarie Orman, via the Oakley key exchange protocol, has significantly influenced the design of ISAKMP.

Marsha Gross, Bill Kutz, Mike Oehler, Pete Sell, and Ruth Taylor provided significant input and review to this document.

Scott Carlson ported the TIS DNSSEC prototype to FreeBSD for use with the ISAKMP prototype.

Jeff Turner and Steve Smalley contributed to the prototype development and integration with ESP and AH.

Mike Oehler and Pete Sell performed interoperability testing with other ISAKMP implementors.

Thanks to Carl Muckenhirn of SPARTA, Inc. for his assistance with LaTeX.

References

- [ANSI] ANSI, X9.42: Public Key Cryptography for the Financial Services Industry -- Establishment of Symmetric Algorithm Keys Using Diffie-Hellman, Working Draft, April 19, 1996.
- [BC] Ballardie, A., and J. Crowcroft, Multicast-specific Security Threats and Countermeasures, Proceedings of 1995 ISOC Symposium on Networks & Distributed Systems Security, pp. 17-30, Internet Society, San Diego, CA, February 1995.
- [Berge] Berge, N., "UNINETT PCA Policy Statements", RFC 1875, December 1995.

- [CW87] Clark, D.D. and D.R. Wilson, A Comparison of Commercial and Military Computer Security Policies, Proceedings of the IEEE Symposium on Security & Privacy, Oakland, CA, 1987, pp. 184-193.
- [DNSSEC] D. Eastlake III, Domain Name System Protocol Security Extensions, Work in Progress.
- [DOW92] Diffie, W., M.Wiener, P. Van Oorschot, Authentication and Authenticated Key Exchanges, Designs, Codes, and Cryptography, 2, 107-125, Kluwer Academic Publishers, 1992.
- [IAB] Bellovin, S., "Report of the IAB Security Architecture Workshop", RFC 2316, April 1998.
- [IKE] Harkins, D., and D. Carrel, "The Internet Key Exchange (IKE)", RFC 2409, November 1998.
- [IPDOI] Piper, D., "The Internet IP Security Domain of Interpretation for ISAKMP", RFC 2407, November 1998.
- [Karn] Karn, P., and B. Simpson, Photuris: Session Key Management Protocol, Work in Progress.
- [Kent94] Steve Kent, IPSEC SMIB, e-mail to ipsec@ans.net, August 10, 1994.
- [Oakley] Orman, H., "The Oakley Key Determination Protocol", RFC 2412, November 1998.
- [RFC-1422] Kent, S., "Privacy Enhancement for Internet Electronic Mail: Part II: Certificate-Based Key Management", RFC 1422, February 1993.
- [RFC-1949] Ballardie, A., "Scalable Multicast Key Distribution", RFC 1949, May 1996.
- [RFC-2093] Harney, H., and C. Muckenhirn, "Group Key Management Protocol (GKMP) Specification", RFC 2093, July 1997.
- [RFC-2094] Harney, H., and C. Muckenhirn, "Group Key Management Protocol (GKMP) Architecture", RFC 2094, July 1997.
- [RFC-2119] Bradner, S., "Key Words for use in RFCs to Indicate Requirement Levels", BCP 14, RFC 2119, March 1997.

- [Schneier] Bruce Schneier, Applied Cryptography - Protocols, Algorithms, and Source Code in C (Second Edition), John Wiley & Sons, Inc., 1996.
- [SEC-ARCH] Atkinson, R., and S. Kent, "Security Architecture for the Internet Protocol", RFC 2401, November 1998.
- [STD-2] Reynolds, J., and J. Postel, "Assigned Numbers", STD 2, RFC 1700, October 1994. See also:
<http://www.iana.org/numbers.html>

Authors' Addresses

Douglas Maughan
National Security Agency
ATTN: R23
9800 Savage Road
Ft. Meade, MD. 20755-6000

Phone: 301-688-0847
EMail:wdm@tycho.ncsc.mil

Mark Schneider
National Security Agency
ATTN: R23
9800 Savage Road
Ft. Meade, MD. 20755-6000

Phone: 301-688-0851
EMail:mss@tycho.ncsc.mil

Mark Schertler
Securify, Inc.
2415-B Charleston Road
Mountain View, CA 94043

Phone: 650-934-9303
EMail:mjs@securify.com

Jeff Turner
RABA Technologies, Inc.
10500 Little Patuxent Parkway
Columbia, MD. 21044

Phone: 410-715-9399
EMail:jeff.turner@raba.com

Full Copyright Statement

Copyright (C) The Internet Society (1998). All Rights Reserved.

This document and translations of it may be copied and furnished to others, and derivative works that comment on or otherwise explain it or assist in its implementation may be prepared, copied, published and distributed, in whole or in part, without restriction of any kind, provided that the above copyright notice and this paragraph are included on all such copies and derivative works. However, this document itself may not be modified in any way, such as by removing the copyright notice or references to the Internet Society or other Internet organizations, except as needed for the purpose of developing Internet standards in which case the procedures for copyrights defined in the Internet Standards process must be followed, or as required to translate it into languages other than English.

The limited permissions granted above are perpetual and will not be revoked by the Internet Society or its successors or assigns.

This document and the information contained herein is provided on an "AS IS" basis and THE INTERNET SOCIETY AND THE INTERNET ENGINEERING TASK FORCE DISCLAIMS ALL WARRANTIES, EXPRESS OR IMPLIED, INCLUDING BUT NOT LIMITED TO ANY WARRANTY THAT THE USE OF THE INFORMATION HEREIN WILL NOT INFRINGE ANY RIGHTS OR ANY IMPLIED WARRANTIES OF MERCHANTABILITY OR FITNESS FOR A PARTICULAR PURPOSE.

