

Internet Engineering Task Force (IETF)  
Request for Comments: 8105  
Category: Standards Track  
ISSN: 2070-1721

P. Mariager  
J. Petersen, Ed.  
RTX A/S  
Z. Shelby  
ARM  
M. van de Logt  
Bosch Sensortec GmbH  
D. Barthel  
Orange Labs  
May 2017

Transmission of IPv6 Packets over Digital Enhanced Cordless  
Telecommunications (DECT) Ultra Low Energy (ULE)

Abstract

Digital Enhanced Cordless Telecommunications (DECT) Ultra Low Energy (ULE) is a low-power air interface technology that is proposed by the DECT Forum and is defined and specified by ETSI.

The DECT air interface technology has been used worldwide in communication devices for more than 20 years. It has primarily been used to carry voice for cordless telephony but has also been deployed for data-centric services.

DECT ULE is a recent addition to the DECT interface primarily intended for low-bandwidth, low-power applications such as sensor devices, smart meters, home automation, etc. As the DECT ULE interface inherits many of the capabilities from DECT, it benefits from operation that is long-range and interference-free, worldwide-reserved frequency band, low silicon prices, and maturity. There is an added value in the ability to communicate with IPv6 over DECT ULE, such as for Internet of Things applications.

This document describes how IPv6 is transported over DECT ULE using IPv6 over Low-Power Wireless Personal Area Network (6LoWPAN) techniques.

## Status of This Memo

This is an Internet Standards Track document.

This document is a product of the Internet Engineering Task Force (IETF). It represents the consensus of the IETF community. It has received public review and has been approved for publication by the Internet Engineering Steering Group (IESG). Further information on Internet Standards is available in Section 2 of RFC 7841.

Information about the current status of this document, any errata, and how to provide feedback on it may be obtained at <http://www.rfc-editor.org/info/rfc8105>.

## Copyright Notice

Copyright (c) 2017 IETF Trust and the persons identified as the document authors. All rights reserved.

This document is subject to BCP 78 and the IETF Trust's Legal Provisions Relating to IETF Documents (<http://trustee.ietf.org/license-info>) in effect on the date of publication of this document. Please review these documents carefully, as they describe your rights and restrictions with respect to this document. Code Components extracted from this document must include Simplified BSD License text as described in Section 4.e of the Trust Legal Provisions and are provided without warranty as described in the Simplified BSD License.

## Table of Contents

1. Introduction . . . . .	4
1.1. Requirements Notation . . . . .	5
1.2. Terms Used . . . . .	5
2. DECT Ultra Low Energy . . . . .	6
2.1. The DECT ULE Protocol Stack . . . . .	6
2.2. Link Layer Roles and Topology . . . . .	8
2.3. Addressing Model . . . . .	8
2.4. MTU Considerations . . . . .	9
2.5. Additional Considerations . . . . .	9
3. Specification of IPv6 over DECT ULE . . . . .	9
3.1. Protocol Stack . . . . .	10
3.2. Link Model . . . . .	11
3.3. Subnets and Internet Connectivity Scenarios . . . . .	15
4. IANA Considerations . . . . .	17
5. Security Considerations . . . . .	17
6. ETSI Considerations . . . . .	18
7. References . . . . .	18
7.1. Normative References . . . . .	18
7.2. Informative References . . . . .	20
Acknowledgements . . . . .	21
Authors' Addresses . . . . .	22

## 1. Introduction

Digital Enhanced Cordless Telecommunications (DECT) is a standard series [EN300.175-part1-7] specified by ETSI, and CAT-iq (Cordless Advanced Technology - internet and quality) is a set of product certification and interoperability profiles [CAT-iq] defined by DECT Forum. DECT Ultra Low Energy (DECT ULE or just ULE) is an air interface technology building on the key fundamentals of traditional DECT/CAT-iq but with specific changes to significantly reduce the power consumption at the expense of data throughput. DECT ULE devices with requirements on power consumption, as specified by ETSI in [TS102.939-1] and [TS102.939-2], will operate on special power-optimized silicon but can connect to a DECT Gateway supporting traditional DECT/CAT-iq for cordless telephony and data as well as the ULE extensions.

DECT terminology has two major role definitions: the Portable Part (PP) is the power-constrained device while the Fixed Part (FP) is the Gateway or base station. This FP may be connected to the Internet. An example of a use case for DECT ULE is a home-security sensor transmitting small amounts of data (few bytes) at periodic intervals through the FP but that is able to wake up upon an external event (e.g., a break-in) and communicate with the FP. Another example incorporating both DECT ULE and traditional CAT-iq telephony would be a pendant (brooch) for the elderly that generally transmits periodic status messages to a care provider using very little battery, but in the event of an emergency, the elderly person can establish a voice connection through the pendant to an alarm service. It is expected that DECT ULE will be integrated into many residential gateways, as many of these already implement DECT CAT-iq for cordless telephony. DECT ULE can be added as a software option for the FP.

It is desirable to consider IPv6 for DECT ULE devices due to the large address space and well-known infrastructure. This document describes how IPv6 is used on DECT ULE links to optimize power while maintaining the many benefits of IPv6 transmission. [RFC4944], [RFC6282], and [RFC6775] specify the transmission of IPv6 over IEEE 802.15.4. DECT ULE has many characteristics similar to those of IEEE 802.15.4, but it also has differences. A subset of mechanisms defined for transmission of IPv6 over IEEE 802.15.4 can be applied to the transmission of IPv6 on DECT ULE links.

This document specifies how to map IPv6 over DECT ULE inspired by [RFC4944], [RFC6282], [RFC6775], and [RFC7668].

### 1.1. Requirements Notation

The key words "MUST", "MUST NOT", "REQUIRED", "SHALL", "SHALL NOT", "SHOULD", "SHOULD NOT", "RECOMMENDED", "NOT RECOMMENDED", "MAY", and "OPTIONAL" in this document are to be interpreted as described in [RFC2119].

### 1.2. Terms Used

6CO	6LoWPAN Context Option [RFC6775]
6BBR	6LoWPAN Backbone Router
6LBR	6LoWPAN Border Router, as defined in [RFC6775]. The DECT Fixed Part has this role.
6LN	6LoWPAN Node as defined in [RFC6775]. The DECT Portable Part has this role
6LoWPAN	IPv6 over Low-Power Wireless Personal Area Network
AES128	Advanced Encryption Standard with a key size of 128 bits
API	Application Programming Interface
ARO	Address Registration Option [RFC6775]
CAT-iq	Cordless Advanced Technology - internet and quality
CID	Context Identifier [RFC6775]
DAC	Destination Address Compression
DAD	Duplicate Address Detection [RFC4862]
DAM	Destination Address Mode
DHCPv6	Dynamic Host Configuration Protocol for IPv6 [RFC3315]
DLC	Data Link Control
DSAA2	DECT Standard Authentication Algorithm #2
DSC	DECT Standard Cipher
DSC2	DECT Standard Cipher #2
FDMA	Frequency-Division Multiple Access
FP	DECT Fixed Part; the Gateway
GAP	Generic Access Profile
IID	Interface Identifier
IPEI	International Portable Equipment Identity; DECT identity
MAC-48	48-bit global unique MAC address managed by IEEE
MAC	Media Access Control
MTU	Maximum Transmission Unit
NBMA	Non-Broadcast Multi-Access
ND	Neighbor Discovery [RFC4861] [RFC6775]
PDU	Protocol Data Unit
PHY	Physical Layer
PMID	Portable MAC Identity; DECT identity
PP	DECT Portable Part; typically the sensor node (6LN)
PVC	Permanent Virtual Circuit
RFPI	Radio Fixed Part Identity; DECT identity
SAC	Source Address Compression
SAM	Source Address Mode
TDD	Time Division Duplex

TDMA      Time-Division Multiple Access  
TPUI      Temporary Portable User Identity; DECT identity  
UAK      User Authentication Key; DECT master security key  
ULA      Unique Local Address [RFC4193]

## 2. DECT Ultra Low Energy

DECT ULE is a low-power air interface technology that is designed to support both circuit-switched services, such as voice communication, and packet-mode data services at a modest data rate. This document is only addressing the packet-mode data service of DECT ULE.

### 2.1. The DECT ULE Protocol Stack

The DECT ULE Protocol Stack contains a PHY layer operating at frequencies in the 1880 - 1920 MHz frequency band depending on the region and uses a symbol rate of 1.152 Mbaud. Radio bearers are allocated by use of FDMA/TDMA/TDD techniques.

In its generic network topology, DECT is defined as a cellular network technology. However, the most common configuration is a star network with a single FP defining the network with a number of PPs attached. The MAC layer supports both traditional DECT circuit mode operation, as this is used for services like discovery, pairing, security features, etc., and it supports new ULE packet-mode operation. The circuit-mode features have been reused from DECT.

The DECT ULE device can switch to the ULE mode of operation, utilizing the new ULE MAC layer features. The DECT ULE Data Link Control (DLC) provides multiplexing as well as segmentation and reassembly for larger packets from layers above. The DECT ULE layer also implements per-message authentication and encryption. The DLC layer ensures packet integrity and preserves packet order, but delivery is based on best effort.

The current DECT ULE MAC layer standard supports low-bandwidth data broadcast. However, this document is not considering usage of the DECT ULE MAC layer broadcast service for IPv6 over DECT ULE.

In general, communication sessions can be initiated from both the FP side and the PP side. Depending on power-down modes employed in the PP, latency may occur when initiating sessions from the FP side. MAC layer communication can take place using either connection-oriented packet transfer with low overhead for short sessions or connection-oriented bearers including media reservation. The MAC layer autonomously selects the radio-spectrum positions that are available

within the band and can rearrange these to avoid interference. The MAC layer has built-in retransmission procedures in order to improve transmission reliability.

The DECT ULE device will typically incorporate an Application Programming Interface (API), as well as common elements known as Generic Access Profiles (GAPs), for enrolling into the network. The DECT ULE Stack establishes a Permanent Virtual Circuit (PVC) for the application layers and provides support for a range of different application protocols. The application protocol is negotiated between the PP and FP when the PVC communication service is established. [TS102.939-1] defines this negotiation and specifies an Application Protocol Identifier set to 0x06 for 6LoWPAN. This document defines the behavior of that application protocol.

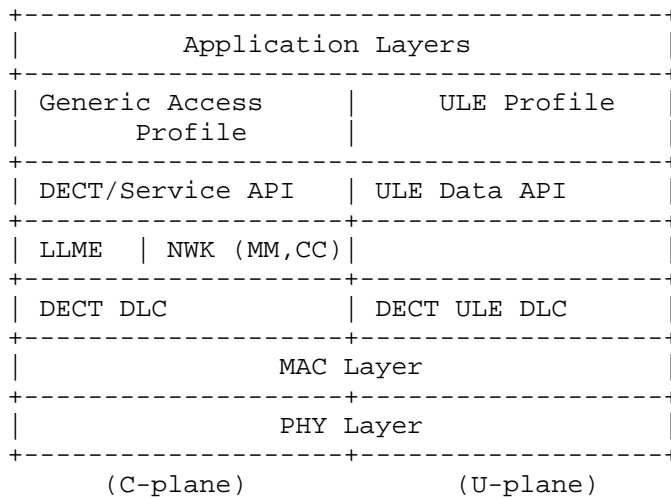

Figure 1: DECT ULE Protocol Stack

Figure 1 shows the DECT ULE Stack divided into the Control Plane (C-plane) and User Data Plane (U-plane), to the left and to the right, respectively. The shown entities in the Stack are the Physical Layer (PHY), Media Access Control (MAC) Layer, Data Link Control (DLC) Layer, and Network Layer (NWK), along with following subcomponents: Lower-Layer Management Entity (LLME), Mobility Management (MM), and Call Control (CC). Above there are the typical Application Programmers Interface (API) and application-profile-specific layers.

## 2.2. Link Layer Roles and Topology

An FP is assumed to be less constrained than a PP. Hence, in the primary scenario, the FP and PP will act as 6LBR and a 6LN, respectively. This document only addresses this primary scenario, and all other scenarios with different roles of an FP and PP are out of scope.

In DECT ULE, at the link layer, the communication only takes place between an FP and a PP. An FP is able to handle multiple simultaneous connections with a number of PPs. Hence, in a DECT ULE network using IPv6, a radio hop is equivalent to an IPv6 link and vice versa (see Section 3.3).

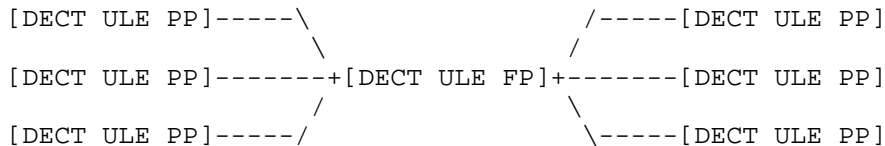

Figure 2: DECT ULE Star Topology

A significant difference between IEEE 802.15.4 and DECT ULE is that the former supports both star and mesh topology (and requires a routing protocol), whereas DECT ULE in its primary configuration does not support the formation of multihop networks at the link layer. In consequence, the mesh header defined in [RFC4944] is not used in DECT ULE networks.

DECT ULE repeaters are considered to operate transparently in the DECT protocol domain and are outside the scope of this document.

## 2.3. Addressing Model

Each DECT PP is assigned an IPEI during manufacturing. This identity has the size of 40 bits and is globally unique within DECT addressing space and can be used to constitute the MAC address used to derive the IID for link-local address.

During a DECT location registration procedure, the FP assigns a 20-bit TPUI to a PP. The FP creates a unique mapping between the assigned TPUI and the IPEI of each PP. This TPUI is used for addressing (Layer 2) in messages between the FP and PP. Although the TPUI is temporary by definition, many implementations assign the same value repeatedly to any given PP, hence it seems not suitable for construction of the IID (see [RFC8065]).



Each DECT FP is assigned an RFPI during manufacturing. This identity has the size of 40 bits and is globally unique within DECT addressing space and can be used to constitute the MAC address used to derive the IID for link-local address.

Optionally, each DECT PP and DECT FP can be assigned a unique (IEEE) MAC-48 address in addition to the DECT identities to be used by the 6LoWPAN. During the address registration of non-link-local addresses as specified by this document, the FP and PP can use such MAC-48 to construct the IID. However, as these addresses are considered as being permanent, such a scheme is NOT RECOMMENDED as per [RFC8065].

#### 2.4. MTU Considerations

Ideally, the DECT ULE FP and PP may generate data that fits into a single MAC layer packet (38 octets) for periodically transferred information, depending on application. However, IP packets may be much larger. The DECT ULE DLC procedures natively support segmentation and reassembly and provide any MTU size below 65536 octets. The default MTU size defined in DECT ULE [TS102.939-1] is 500 octets. In order to support complete IPv6 packets, the DLC layer of DECT ULE SHALL, per this specification, be configured with an MTU size of 1280 octets, hence [RFC4944] fragmentation/reassembly is not required.

It is important to realize that the usage of larger packets will be at the expense of battery life, as a large packet inside the DECT ULE Stack will be fragmented into several or many MAC layer packets, each consuming power to transmit/receive. The increased MTU size does not change the MAC layer packet and PDU size.

#### 2.5. Additional Considerations

The DECT ULE standard allows the PP to be DECT-registered (bound) to multiple FP and to roam between them. These FP and their 6LBR functionalities can operate either individually or connected through a Backbone Router as per [BACKBONE-ROUTER].

### 3. Specification of IPv6 over DECT ULE

Before any IP-layer communications can take place over DECT ULE, DECT-ULE-enabled nodes such as 6LNs and 6LBRs have to find each other and establish a suitable link layer connection. The obtain-access-rights registration and location registration procedures are documented by ETSI in the specifications [EN300.175-part1-7], [TS102.939-1], and [TS102.939-2].

DECT ULE technology sets strict requirements for low power consumption and, thus, limits the allowed protocol overhead. 6LoWPAN standards [RFC4944], [RFC6775], and [RFC6282] provide useful functionality for reducing overhead that can be applied to DECT ULE. This functionality comprises link-local IPv6 addresses and stateless IPv6 address autoconfiguration, Neighbor Discovery, and header compression.

The ULE 6LoWPAN adaptation layer can run directly on this U-plane DLC layer. Figure 3 illustrates an IPv6 over DECT ULE Stack.

Because DECT ULE in its primary configuration does not support the formation of multihop networks at the link layer, the mesh header defined in [RFC4944] for mesh under routing MUST NOT be used. In addition, the role of a 6LoWPAN Router (6LR) is not defined per this specification.

### 3.1. Protocol Stack

In order to enable data transmission over DECT ULE, a Permanent Virtual Circuit (PVC) has to be configured and opened between the FP and PP. This is done by setting up a DECT service call between the PP and FP. In the DECT protocol domain, the PP SHALL specify the <<IWU-ATTRIBUTES>> in a service-change (other) message before sending a service-change (resume) message as defined in [TS102.939-1]. The <<IWU-ATTRIBUTES>> SHALL set the ULE Application Protocol Identifier to 0x06 and the MTU size to 1280 octets or larger. The FP sends a service-change-accept (resume) that MUST contain a valid paging descriptor. The PP MUST listen to paging messages from the FP according to the information in the received paging descriptor. Following this, transmission of IPv6 packets can start.

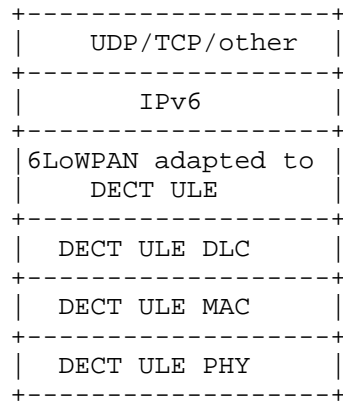

Figure 3: IPv6 over DECT ULE Stack

### 3.2. Link Model

The general model is that IPv6 is Layer 3 and DECT ULE MAC and DECT ULE DLC are Layer 2. DECT ULE already implements fragmentation and reassembly functionality; hence, the fragmentation and reassembly function described in [RFC4944] MUST NOT be used.

After the FPs and PPs have connected at the DECT ULE level, the link can be considered up and IPv6 address configuration and transmission can begin. The 6LBR ensures address collisions do not occur.

Per this specification, the IPv6 header compression format specified in [RFC6282] MUST be used. The IPv6 payload length can be derived from the ULE DLC packet length. The possibly elided IPv6 address can be reconstructed from the lower layer address (see Section 3.2.4).

Due to the DECT ULE star topology (see Section 2.2), each PP has a separate link to the FP; thus, the PPs cannot directly hear one another and cannot talk to one another. As discussed in [RFC4903], conventional usage of IPv6 anticipates IPv6 subnets spanning a single link at the link layer. In order to avoid the complexity of implementing a separate subnet for each DECT ULE link, a Multi-Link Subnet model [RFC4903] has been chosen, specifically Non-Broadcast Multi-Access (NBMA) at Layer 2. Because of this, link-local multicast communications can happen only within a single DECT ULE connection; thus, 6LN-to-6LN communications using link-local addresses are not possible. 6LNs connected to the same 6LBR have to communicate with each other utilizing the shared prefix used on the subnet. The 6LBR forwards packets sent by one 6LN to another.

#### 3.2.1. Stateless Address Autoconfiguration

At network interface initialization, both 6LN and 6LBR SHALL generate and assign IPv6 link-local addresses to the DECT ULE network interfaces [RFC4862] based on the DECT device addresses (see Section 2.3) that were used for establishing the underlying DECT ULE connection.

The DECT device addresses IPEI and RFPI MUST be used to derive the IPv6 link-local 64-bit Interface Identifiers (IIDs) for 6LN and 6LBR, respectively.

The rule for deriving IIDs from DECT device addresses is as follows: the DECT device addresses that consist of 40 bits each MUST be expanded with leading zero bits to form 48-bit intermediate addresses. The most significant bit in this newly formed 48-bit intermediate address is set to one for addresses derived from the RFPI and set to zero for addresses derived from the IPEI. 64-bit IIDs

are derived from these intermediate 48-bit addresses following the guidance in Appendix A of [RFC4291]. However, because DECT and IEEE address spaces are different, this intermediate address cannot be considered to be unique within an IEEE address space. In the derived IIDs, the Universal/Local (U/L) bit (7th bit) will be zero, which indicates that derived IIDs are not globally unique, see [RFC7136]. For example, from RFPI=11.22.33.44.55, the derived IID is 80:11:22:ff:fe:33:44:55; from IPEI=01.23.45.67.89, the derived IID is 00:01:23:ff:fe:45:67:89.

Global uniqueness of an IID in link-local addresses is not required as they should never be leaked outside the subnet domain.

As defined in [RFC4291], the IPv6 link-local address is formed by appending the IID to the prefix FE80::/64, as shown in Figure 4.

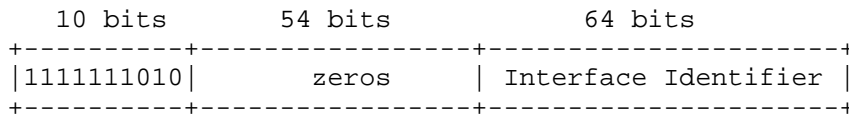

Figure 4: IPv6 Link-Local Address in DECT ULE

A 6LN MUST join the all-nodes multicast address.

After link-local address configuration, 6LN sends Router Solicitation messages as described in Section 6.3.7 of [RFC4861] and Section 5.3 of [RFC6775].

For non-link-local addresses, 6LNs SHOULD NOT be configured to use IIDs derived from a MAC-48 device address or DECT device addresses. Alternative schemes such as Cryptographically Generated Addresses (CGAs) [RFC3972], privacy extensions [RFC4941], Hash-Based Addresses (HBAs) [RFC5535], DHCPv6 [RFC3315], or static, semantically opaque addresses [RFC7217] SHOULD be used by default. See also [RFC8065] for guidance of needed entropy in IIDs and the recommended lifetime of used IIDs. When generated IIDs are not globally unique, Duplicate Address Detection (DAD) [RFC4862] MUST be used. In situations where deployment constraints require the device's address to be embedded in the IID, the 6LN MAY form a 64-bit IID by utilizing the MAC-48 device address or DECT device addresses. The non-link-local addresses that a 6LN generates MUST be registered with 6LBR as described in Section 3.2.2.

The means for a 6LBR to obtain an IPv6 prefix for numbering the DECT ULE network is out of scope of this document, but a prefix can be, for example, assigned via DHCPv6 Prefix Delegation [RFC3633] or using IPv6 Unicast Unique Local Addresses (ULAs) [RFC4193]. Due to the

link model of the DECT ULE, the 6LBR MUST set the "on-link" (L) flag to zero in the Prefix Information Option [RFC4861]. This will cause 6LNs to always send packets to the 6LBR, including the case when the destination is another 6LN using the same prefix.

### 3.2.2. Neighbor Discovery

"Neighbor Discovery Optimization for IPv6 over Low-Power Wireless Personal Area Networks (6LoWPANs)" [RFC6775] describes the Neighbor Discovery approach as adapted for use in several 6LoWPAN topologies, including the mesh topology. As DECT ULE does not support mesh networks, only those aspects of [RFC6775] that apply to star topology are considered.

The following aspects of the Neighbor Discovery optimizations [RFC6775] are applicable to DECT ULE 6LNs:

1. For sending Router Solicitations and processing Router Advertisements the DECT ULE 6LNs MUST, respectively, follow Sections 5.3 and 5.4 of the [RFC6775].
2. A DECT ULE 6LN MUST NOT register its link-local address. Because the IIDs used in link-local addresses are derived from DECT addresses, there will always exist a unique mapping between link-local and Layer 2 addresses.
3. A DECT ULE 6LN MUST register its non-link-local addresses with the 6LBR by sending a Neighbor Solicitation (NS) message with the Address Registration Option (ARO) and process the Neighbor Advertisement (NA) accordingly. The NS with the ARO option MUST be sent irrespective of the method used to generate the IID.

### 3.2.3. Unicast and Multicast Address Mapping

The DECT MAC layer broadcast service is considered inadequate for IP multicast because it does not support the MTU size required by IPv6.

Hence, traffic is always unicast between two DECT ULE nodes. Even in the case where a 6LBR is attached to multiple 6LNs, the 6LBR cannot do a multicast to all the connected 6LNs. If the 6LBR needs to send a multicast packet to all its 6LNs, it has to replicate the packet and unicast it on each link. However, this may not be energy efficient and particular care should be taken if the FP is battery-powered. To further conserve power, the 6LBR MUST keep track of multicast listeners at DECT ULE link-level granularity, and it MUST NOT forward multicast packets to 6LNs that have not registered for multicast groups the packets belong to. In the opposite direction, a 6LN can only transmit data to or through the 6LBR. Hence, when a 6LN

needs to transmit an IPv6 multicast packet, the 6LN will unicast the corresponding DECT ULE packet to the 6LBR. The 6LBR will then forward the multicast packet to other 6LNs.

#### 3.2.4. Header Compression

As defined in [RFC6282], which specifies the compression format for IPv6 datagrams on top of IEEE 802.15.4, header compression is REQUIRED in this document as the basis for IPv6 header compression on top of DECT ULE. All headers MUST be compressed according to encoding formats as described in [RFC6282]. The DECT ULE's star topology structure, ARO and 6CO, can be exploited in order to provide a mechanism for address compression. The following text describes the principles of IPv6 address compression on top of DECT ULE.

##### 3.2.4.1. Link-Local Header Compression

In a link-local communication terminated at 6LN and 6LBR, both the IPv6 source and destination addresses MUST be elided since the used IIDs map uniquely into the DECT link end-point addresses. A 6LN or 6LBR that receives a PDU containing an IPv6 packet can infer the corresponding IPv6 source address. For the unicast type of communication considered in this paragraph, the following settings MUST be used in the IPv6 compressed header: CID=0, SAC=0, SAM=11, DAC=0, and DAM=11.

##### 3.2.4.2. Non-link-local Header Compression

To enable efficient header compression, the 6LBR MUST include the 6LoWPAN Context Option (6CO) [RFC6775] for all prefixes the 6LBR advertises in Router Advertisements for use in stateless address autoconfiguration.

When a 6LN transmits an IPv6 packet to a destination using global unicast IPv6 addresses, if a context is defined for the prefix of the 6LNs global IPv6 address, the 6LN MUST indicate this context in the corresponding source fields of the compressed IPv6 header as per Section 3.1 of [RFC6282] and MUST fully elide the latest registered IPv6 source address. For this, the 6LN MUST use the following settings in the IPv6 compressed header: CID=1, SAC=1, and SAM=11. In this case, the 6LBR can infer the elided IPv6 source address since 1) the 6LBR has previously assigned the prefix to the 6LNs and 2) the 6LBR maintains a Neighbor Cache that relates the device address and the IID of the corresponding PP. If a context is defined for the IPv6 destination address, the 6LN MUST also indicate this context in the corresponding destination fields of the compressed IPv6 header and MUST elide the prefix of the destination IPv6 address. For this, the 6LN MUST set the DAM field of the compressed IPv6 header as

CID=1, DAC=1, and DAM=01 or DAM=11. Note that when a context is defined for the IPv6 destination address, the 6LBR can infer the elided destination prefix by using the context.

When a 6LBR receives an IPv6 packet having a global unicast IPv6 address and the destination of the packet is a 6LN, if a context is defined for the prefix of the 6LN's global IPv6 address, the 6LBR MUST indicate this context in the corresponding destination fields of the compressed IPv6 header and MUST fully elide the IPv6 destination address of the packet if the destination address is the latest registered by the 6LN for the indicated context. For this, the 6LBR MUST set the DAM field of the IPv6 compressed header as DAM=11. CID and DAC MUST be set to CID=1 and DAC=1. If a context is defined for the prefix of the IPv6 source address, the 6LBR MUST indicate this context in the source fields of the compressed IPv6 header and MUST elide that prefix as well. For this, the 6LBR MUST set the SAM field of the IPv6 compressed header as CID=1, SAC=1, and SAM=01 or SAM=11.

### 3.3. Subnets and Internet Connectivity Scenarios

In the DECT ULE star topology (see Section 2.2), each PP has a separate link to the FP, and the FP acts as an IPv6 router rather than a link layer switch. A Multi-Link Subnet model [RFC4903] has been chosen, specifically Non-Broadcast Multi-Access (NBMA) at Layer 2, as is further illustrated in Figure 5. The 6LBR forwards packets sent by one 6LN to another. In a typical scenario, the DECT ULE network is connected to the Internet as shown in the Figure 5. In this scenario, the DECT ULE network is deployed as one subnet using one /64 IPv6 prefix. The 6LBR acts as a router and forwards packets between 6LNs to and from Internet.

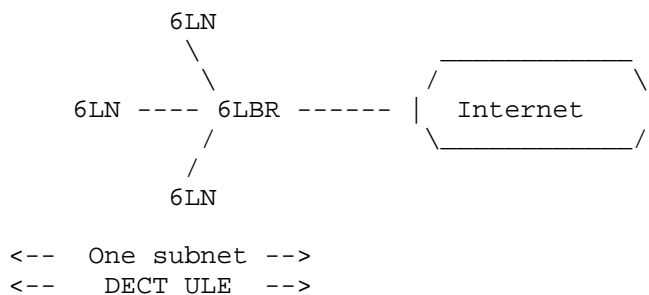

Figure 5: DECT ULE Network Connected to the Internet

In some scenarios, the DECT ULE network may transiently or permanently be an isolated network as shown in the Figure 6. In this case, the whole DECT ULE network consists of a single subnet with multiple links, where 6LBR is routing packets between 6LNs.

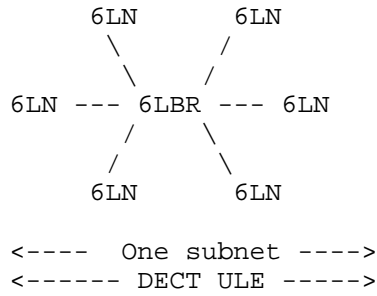

Figure 6: Isolated DECT ULE Network

In the isolated network scenario, communications between 6LN and 6LBR can use IPv6 link-local methodology, but for communications between different PP, the FP has to act as 6LBR, number the network with a ULA prefix [RFC4193], and route packets between the PP.

In other more advanced systems scenarios with multiple FPs and 6LBR, each DECT ULE FP constitutes a wireless cell. The network can be configured as a Multi-Link Subnet in which the 6LN can operate within the same /64 subnet prefix in multiple cells as shown in the Figure 7. The FPs in such a scenario should behave as Backbone Routers (6BBR) as defined in [BACKBONE-ROUTER].

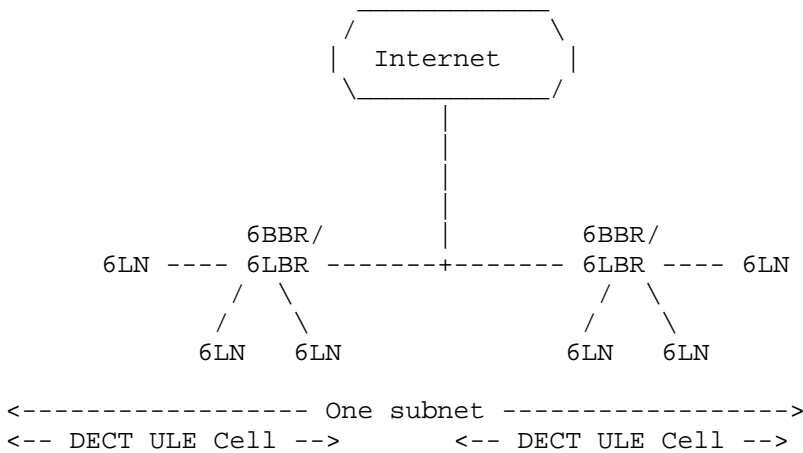

Figure 7: Multiple DECT ULE Cells in a Single Multi-link Subnet



#### 4. IANA Considerations

This document does not require any IANA actions.

#### 5. Security Considerations

The secure transmission of circuit mode services in DECT is based on the DSAA2 and DSC/DSC2 specifications developed by ETSI Technical Committee (TC) DECT and the ETSI Security Algorithms Group of Experts (SAGE).

DECT ULE communications are secured at the link layer (DLC) by encryption and per-message authentication through CCM (Counter with Cipher Block Chaining Message Authentication Code (CBC-MAC)) mode similar to [RFC3610]. The underlying algorithm for providing encryption and authentication is AES128.

The DECT ULE pairing procedure generates a master User Authentication Key (UAK). During the location registration procedure, or when the permanent virtual circuits are established, the session security keys are generated. Both the master authentication key and session security keys are generated by use of the DSAA2 algorithm [EN300.175-part1-7], which uses AES128 as the underlying algorithm. Session security keys may be renewed regularly. The generated security keys (UAK and session security keys) are individual for each FP-PP binding; hence, all PPs in a system have different security keys. DECT ULE PPs do not use any shared encryption key.

Even though DECT ULE offers link layer security, it is still recommended to use secure transport or application protocols above 6LoWPAN.

From the privacy point of view, the IPv6 link-local address configuration described in Section 3.2.1 only reveals information about the 6LN to the 6LBR that the 6LBR already knows from the link layer connection. For non-link-local IPv6 addresses, by default, a 6LN SHOULD use a randomly generated IID, for example, as discussed in [RFC8064], or use alternative schemes such as Cryptographically Generated Addresses (CGAs) [RFC3972], privacy extensions [RFC4941], Hash-Based Addresses (HBAs, [RFC5535]), or static, semantically opaque addresses [RFC7217].

## 6. ETSI Considerations

ETSI is standardizing a list of known application-layer protocols that can use the DECT ULE permanent virtual circuit packet data service. Each protocol is identified by a unique known identifier, which is exchanged in the service-change procedure as defined in [TS102.939-1]. The IPv6/6LoWPAN as described in this document is considered to be an application-layer protocol on top of DECT ULE. In order to provide interoperability between 6LoWPAN / DECT ULE devices, a common protocol identifier for 6LoWPAN is standardized by ETSI.

The ETSI DECT ULE Application Protocol Identifier is set to 0x06 for 6LoWPAN [TS102.939-1].

## 7. References

### 7.1. Normative References

- [EN300.175-part1-7] ETSI, "Digital Enhanced Cordless Telecommunications (DECT); Common Interface (CI); Part 1: Overview", European Standard, ETSI EN 300 175-1, V2.6.1, July 2015, <[https://www.etsi.org/deliver/etsi\\_en/300100\\_300199/30017501/02.06.01\\_60/en\\_30017501v020601p.pdf](https://www.etsi.org/deliver/etsi_en/300100_300199/30017501/02.06.01_60/en_30017501v020601p.pdf)>.
- [RFC2119] Bradner, S., "Key words for use in RFCs to Indicate Requirement Levels", BCP 14, RFC 2119, DOI 10.17487/RFC2119, March 1997, <<http://www.rfc-editor.org/info/rfc2119>>.
- [RFC3633] Troan, O. and R. Droms, "IPv6 Prefix Options for Dynamic Host Configuration Protocol (DHCP) version 6", RFC 3633, DOI 10.17487/RFC3633, December 2003, <<http://www.rfc-editor.org/info/rfc3633>>.
- [RFC4193] Hinden, R. and B. Haberman, "Unique Local IPv6 Unicast Addresses", RFC 4193, DOI 10.17487/RFC4193, October 2005, <<http://www.rfc-editor.org/info/rfc4193>>.
- [RFC4291] Hinden, R. and S. Deering, "IP Version 6 Addressing Architecture", RFC 4291, DOI 10.17487/RFC4291, February 2006, <<http://www.rfc-editor.org/info/rfc4291>>.

- [RFC4861] Narten, T., Nordmark, E., Simpson, W., and H. Soliman, "Neighbor Discovery for IP version 6 (IPv6)", RFC 4861, DOI 10.17487/RFC4861, September 2007, <<http://www.rfc-editor.org/info/rfc4861>>.
- [RFC4862] Thomson, S., Narten, T., and T. Jinmei, "IPv6 Stateless Address Autoconfiguration", RFC 4862, DOI 10.17487/RFC4862, September 2007, <<http://www.rfc-editor.org/info/rfc4862>>.
- [RFC4941] Narten, T., Draves, R., and S. Krishnan, "Privacy Extensions for Stateless Address Autoconfiguration in IPv6", RFC 4941, DOI 10.17487/RFC4941, September 2007, <<http://www.rfc-editor.org/info/rfc4941>>.
- [RFC4944] Montenegro, G., Kushalnagar, N., Hui, J., and D. Culler, "Transmission of IPv6 Packets over IEEE 802.15.4 Networks", RFC 4944, DOI 10.17487/RFC4944, September 2007, <<http://www.rfc-editor.org/info/rfc4944>>.
- [RFC6282] Hui, J., Ed. and P. Thubert, "Compression Format for IPv6 Datagrams over IEEE 802.15.4-Based Networks", RFC 6282, DOI 10.17487/RFC6282, September 2011, <<http://www.rfc-editor.org/info/rfc6282>>.
- [RFC6775] Shelby, Z., Ed., Chakrabarti, S., Nordmark, E., and C. Bormann, "Neighbor Discovery Optimization for IPv6 over Low-Power Wireless Personal Area Networks (6LoWPANs)", RFC 6775, DOI 10.17487/RFC6775, November 2012, <<http://www.rfc-editor.org/info/rfc6775>>.
- [RFC7136] Carpenter, B. and S. Jiang, "Significance of IPv6 Interface Identifiers", RFC 7136, DOI 10.17487/RFC7136, February 2014, <<http://www.rfc-editor.org/info/rfc7136>>.
- [TS102.939-1] ETSI, "Digital Enhanced Cordless Telecommunications (DECT); Ultra Low Energy (ULE); Machine to Machine Communications; Part 1: Home Automation Network (phase 1)", Technical Specification, ETSI TS 102 939-1, V1.2.1, March 2015, <[https://www.etsi.org/deliver/etsi\\_ts/102900\\_102999/10293901/01.02.01\\_60/ts\\_10293901v010201p.pdf](https://www.etsi.org/deliver/etsi_ts/102900_102999/10293901/01.02.01_60/ts_10293901v010201p.pdf)>.

## [TS102.939-2]

ETSI, "Digital Enhanced Cordless Telecommunications (DECT); Ultra Low Energy (ULE); Machine to Machine Communications; Part 2: Home Automation Network (phase 2)", Technical Specification, ETSI TS 102 939-2, V1.1.1, March 2015, <[https://www.etsi.org/deliver/etsi\\_ts/102900\\_102999/10293902/01.01.01\\_60/ts\\_10293902v010101p.pdf](https://www.etsi.org/deliver/etsi_ts/102900_102999/10293902/01.01.01_60/ts_10293902v010101p.pdf)>.

## 7.2. Informative References

## [BACKBONE-ROUTER]

Thubert, P., "IPv6 Backbone Router", Work in Progress, draft-ietf-6lo-backbone-router-03, January 2017.

[CAT-iq] DECT Forum, "CAT-iq at a Glance", January 2016, <[http://www.dect.org/userfiles/Public/DF\\_CAT-iq%20at%20a%20Glance.pdf](http://www.dect.org/userfiles/Public/DF_CAT-iq%20at%20a%20Glance.pdf)>.

[RFC3315] Droms, R., Ed., Bound, J., Volz, B., Lemon, T., Perkins, C., and M. Carney, "Dynamic Host Configuration Protocol for IPv6 (DHCPv6)", RFC 3315, DOI 10.17487/RFC3315, July 2003, <<http://www.rfc-editor.org/info/rfc3315>>.

[RFC3610] Whiting, D., Housley, R., and N. Ferguson, "Counter with CBC-MAC (CCM)", RFC 3610, DOI 10.17487/RFC3610, September 2003, <<http://www.rfc-editor.org/info/rfc3610>>.

[RFC3972] Aura, T., "Cryptographically Generated Addresses (CGA)", RFC 3972, DOI 10.17487/RFC3972, March 2005, <<http://www.rfc-editor.org/info/rfc3972>>.

[RFC4903] Thaler, D., "Multi-Link Subnet Issues", RFC 4903, DOI 10.17487/RFC4903, June 2007, <<http://www.rfc-editor.org/info/rfc4903>>.

[RFC5535] Bagnulo, M., "Hash-Based Addresses (HBA)", RFC 5535, DOI 10.17487/RFC5535, June 2009, <<http://www.rfc-editor.org/info/rfc5535>>.

[RFC7217] Gont, F., "A Method for Generating Semantically Opaque Interface Identifiers with IPv6 Stateless Address Autoconfiguration (SLAAC)", RFC 7217, DOI 10.17487/RFC7217, April 2014, <<http://www.rfc-editor.org/info/rfc7217>>.

- [RFC7668] Nieminen, J., Savolainen, T., Isomaki, M., Patil, B., Shelby, Z., and C. Gomez, "IPv6 over BLUETOOTH(R) Low Energy", RFC 7668, DOI 10.17487/RFC7668, October 2015, <<http://www.rfc-editor.org/info/rfc7668>>.
- [RFC8064] Gont, F., Cooper, A., Thaler, D., and W. Liu, "Recommendation on Stable IPv6 Interface Identifiers", RFC 8064, DOI 10.17487/RFC8064, February 2017, <<http://www.rfc-editor.org/info/rfc8064>>.
- [RFC8065] Thaler, D., "Privacy Considerations for IPv6 Adaptation-Layer Mechanisms", RFC 8065, DOI 10.17487/RFC8065, February 2017, <<http://www.rfc-editor.org/info/rfc8065>>.

#### Acknowledgements

We are grateful to the members of the IETF 6lo working group; this document borrows liberally from their work.

Ralph Droms, Samita Chakrabarti, Kerry Lynn, Suresh Krishnan, Pascal Thubert, Tatuya Jinmei, Dale Worley, and Robert Sparks have provided valuable feedback for this document.

## Authors' Addresses

Peter B. Mariager  
RTX A/S  
Stroemmen 6  
DK-9400 Noerresundby  
Denmark

Email: pm@rtx.dk

Jens Toftgaard Petersen (editor)  
RTX A/S  
Stroemmen 6  
DK-9400 Noerresundby  
Denmark

Email: jtp@rtx.dk

Zach Shelby  
ARM  
150 Rose Orchard  
San Jose, CA 95134  
United States of America

Email: zach.shelby@arm.com

Marco van de Logt  
Bosch Sensortec GmbH  
Gerhard-Kindler-Str. 9  
72770 Reutlingen  
Germany

Email: marco.vandelogt@bosch-sensortec.com

Dominique Barthel  
Orange Labs  
28 chemin du Vieux Chene  
38243 Meylan  
France

Email: dominique.barthel@orange.com

